

LIVE THE
SEA-DOO®
LIFE



Product spec book 2022

Vehicles • Accessories • Parts & Maintenance
Apparel • Play & Licensing Products



Product spec book 2022

Vehicle Specifications

- 6 SPARK®
- 8 SPARK® TRIXX™
- 10 GTI™ 90/130
- 12 GTI™ SE 130/170
- 14 WAKE™ 170
- 16 WAKE™ PRO 230
- 18 GTX™ PRO 130
- 20 GTX' 170 / 230
- 22 GTX' LIMITED 300
- 24 FISHPRO™ Scout 130
- 26 FISHPRO™ Sport 170
- 28 FISHPRO™ Trophy 170
- 30 GTR™ 230
- 32 RXP®-X® RS 300
- 34 RXT®-X® RS 300
- 36 Comparative Chart

Accessories

- 41 Essential Bundles
- 42 Lifestyle Bundles
- 44 LinQ Accessories
- 48 Bags and Storage
- 49 Watersport Accessories
- 50 Steps and Ladder
- 50 Controls and Grips
- 53 Tech Accessories
- 54 Electronics and Electricals
- 58 Body Accessories
- 59 Docking
- 61 Riding Essentials
- 62 Covers
- 64 Single Trailers
- 66 Double Trailers
- 67 Trailer Accessories
- 68 Graphic Kits

Parts & Maintenance

- 71 Replacement Parts
- 73 Performance Accessories
- 74 Maintenance Products
- 75 Engine Oils
- 76 Functionnal Fluids
- 76 Lubricants

Apparel

- 80 What do you need to wear on the water
- 81 Airflow PFD
- 82 Explorer PFD
- 83 PFD decision guide
- 84 Neoprene decision guide
- 85 Personal Flotation Device
- 89 Rashguards
- 91 Wetsuits
- 94 Dry Suits
- 95 Eyewear
- 96 Handwear
- 97 Footwear
- 98 Sportswear
- 104 Sizing Chart
- 105 Notes

For advertising purposes, some scenes depicted in this catalog include professional riders and operators executing maneuvers under ideal and/or controlled conditions. Do not attempt any of these or any other risky maneuvers if they're beyond your level of riding ability, as well as your understanding and respect for the performance of your Sea-Doo watercraft. RIDE SMART FROM THE START. Always ride responsibly and safely. Follow all instructional and safety materials. BRP recommends a minimum operator age of 16 years old for riding a watercraft. Always wear appropriate protective clothing for your type of boating use, including a Coast Guard approved life jacket. Always remember that riding and alcohol/drugs don't mix. Operate your watercraft keeping a safe distance between yourself and others. Always observe applicable local laws and regulations. Because of its ongoing commitment to product quality and innovation, Bombardier Recreational Products Inc. (BRP) reserves the right, at any time, to discontinue or change specifications, prices, designs, features, models or equipment without incurring any obligations. Some models depicted herein may include optional equipment. Prices are based on Manufacturer Suggested Retail Prices. Dealers may sell for a different price. For Canada and US, taxes are not included. Depending on location, products are distributed by BRP US Inc., Bombardier Recreational Products Inc., BRP European Distribution SA, BRP Australia Pty Ltd., BRP Finland Oy., BRP Japan Ltd., BRP Comm & Trade (Shanghai) Co Ltd. or Bombardier Recreational Products Motores da Amazonia Ltda. ® are registered trademarks and TM and the BRP logo are trademarks of Bombardier Recreational Products Inc. or its affiliates. * is a trademark of Bombardier Inc. used under license. Velcro is a registered trademark of Velcro Industries. Slowtide is a trademark of Slowtide LLC. Bluetooth is a registered trademark owned by the Bluetooth SIG, Inc. Garmin and ECHOMAP are trademarks of Garmin Ltd. or its subsidiaries. GTX is a registered trademark of Castrol Limited, used under license. YUASA is a registered trademark of YUASA Batteries Inc. NGK is a registered trademark of NGK Spark Plugs, Ltd. Salt-Away is a trademark of Salt-Away Products. All other company and/or product names are trademarks of their respective holders. © 2021 BRP Inc. All rights reserved.

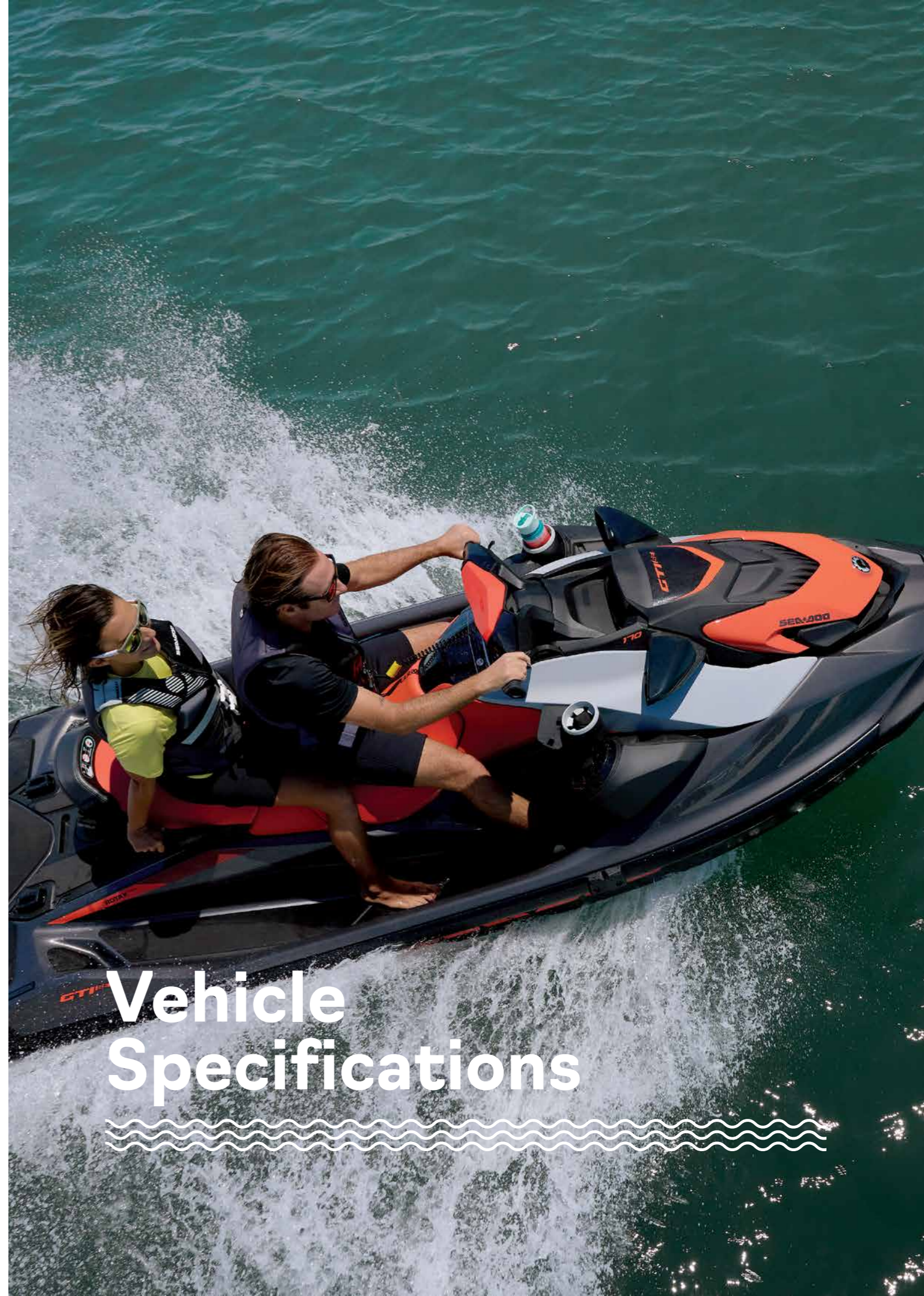

Vehicle Specifications

Vehicle Specifications

- 6 SPARK®
- 8 SPARK® TRIXX™
- 10 GTI™ 90 /130
- 12 GTI™ SE 130 /170
- 14 WAKE™ 170
- 16 WAKE™ PRO 230
- 18 GTX™ PRO 130
- 20 GTX™ 170 / 230
- 22 GTX™ LIMITED 300
- 24 FISHPRO™ Scout 130
- 26 FISHPRO™ Sport 170
- 28 FISHPRO™ Trophy 170
- 30 GTR™ 230
- 32 RXP®-X® RS 300
- 34 RXT®-X® RS 300
- 36 Comparative Chart



SPARK®

One-of-a kind fun.

SPARK®

KEY FEATURES

- Lightweight and playful platform
- Able to tow with most mid-size cars
- Up to 3 passengers
- Options & Accessories:
 - iBR - Intelligent Brake & Reverse
 - BRP Audio - portable system (opt. w/ 3up only)
 - Front storage bin kit
 - Boarding step
 - RF D.E.S.S.™ key*



- NEW Orange Crush & Lava Red
- NEW Reef Blue & Manta Green



NEW Reef Blue & Manta Green

CAPACITY

Model	SPARK® 2up - Rotax® 900 ACE™ - 60	SPARK® 2up - Rotax® 900 ACE™ - 90	SPARK® 3up - Rotax® 900 ACE™ - 90
Rider Capacity	2	2	3
Weight Capacity	160 kg	160 kg	205 kg
Fuel Capacity	30 L		
Glove Box	1.6 L		
Front Bin	27 L (Accessory)		

DIMENSIONS

Length (bumper to bumper)	279 cm	305 cm
Width	118 cm	
Height	104.5 cm	

HULL

Type	SPARK® hull
Material	Polytec™

OTHER FEATURES

- Slim seat
- Seat strap
- LinQ™ attachment system (accessory)
- Wetgrip footboard
- Knee pads
- Handle grips with palm rest
- Tow hook

ROTAX® ENGINE 900 ACE™ - 60 900 ACE™ - 90

Model	Spark 2up	Spark 2up	Spark 3up
Intake System	Naturally aspirated		
Displacement	899 cc		
Cooling	Closed-Loop Cooling System (CLCS)		
Reverse System	Manual Reverse Kit (Accessory)	Manual Reverse Kit (Accessory) Electronic IBR** (Optional)	Manual Reverse Kit (Accessory) Electronic IBR** (Optional)
Fuel Type	95 octane		
Throttle System	iTc™ (Intelligent Throttle Control) system		
Exhaust System	D-Sea-Bel™ system		

GAUGE

Type of Gauge	Compact
Main Functions	• Speedometer • Vehicle hours • RPM
iTC System - Mode	• Sport mode (90 hp only)

WEIGHT

Dry Weight	186 kg	192 kg***	193 kg***
------------	--------	-----------	-----------

WARRANTY

BRP limited warranty covers the watercraft for two years.

FEATURE HIGHLIGHTS



BRP Audio - Portable System (Optional)
High-quality waterproof 50-watt Bluetooth† portable sound system.



Front Storage Bin Kit (Optional)
Additional storage space to bring more gear on board.



Slim Seat
Designed to improve freedom of movement while riding.



ROTAX® 900 ACE™ - 60 / 90
Two fuel-efficient, compact and lightweight Rotax engine options.



Polytec™
Innovative material that reduces weight while optimizing performance and efficiency. The color-in molding is more scratch-resistant than fiberglass.



Boarding Step (Optional)
Makes boarding from the water easier and quicker.

*May not be available at the time of purchase. Please check with your dealer. **Electronic brake, neutral and reverse. ***iBR® and Convenience Package Plus adds 21 lb (9 kg).

†Bluetooth is a registered trademark owned by Bluetooth SIG, Inc. and any use of such trademarks by BRP is under license.

SPARK® TRIXX™

Playful trickster.



KEY FEATURES

- Lightweight and playful platform
- Able to tow with most mid-size cars
- Up to 3 passengers
- BRP Audio - portable system (optional)
- TRIXX™ Package:
 - Handlebar with adjustable riser
 - iBR - Intelligent Brake & Reverse
 - Extended Range VTS
 - Exclusive coloration



- NEW Dazzling Blue & Deep Black
- Lava Red & Deep Black



SPARK® TRIXX™ 3UP with sound system
Lava Red & Deep Black

CAPACITY

Model	SPARK® TRIXX™ 2up	SPARK® TRIXX™ 3up
Rider Capacity	2	3
Weight Capacity	160 kg	205 kg
Fuel Capacity	30 L	
Glove Box	1.6 L	
Front Bin	27 L (accessory)	

DIMENSIONS

Length (bumper to bumper)	279 cm	305 cm
Width	118 cm	
Height	107 cm	

HULL

Type	SPARK® hull
Material	Polytec™

OTHER FEATURES

- Slim seat
- Seat strap
- LinQ™ attachment system (accessory)
- RF D.E.S.S.™ key**
- Wetgrip footboard
- Knee pads
- Handle grip
- Tow hook

ROTAX® ENGINE 900 ACE™ - 90

Model	SPARK® TRIXX™ 2up	SPARK® TRIXX™ 3up
Intake System	Naturally aspirated	
Displacement	899 cc	
Cooling	Closed-Loop Cooling System (CLCS)	
Reverse System	Electronic iBR**	
Fuel Type	95 octane	
Throttle System	iTc™ (Intelligent Throttle Control) system	
Exhaust System	D-Sea-Bel™ system	

GAUGE

Type of Gauge	Compact	
Main Functions	• Speedometer • RPM	• VTS™ display • Vehicle hour display
iTC System - Mode	• Sport mode	

WEIGHT

Dry Weight	194 kg	199 kg
------------	--------	--------

WARRANTY

BRP limited warranty covers the watercraft for two years.

FEATURE HIGHLIGHTS



BRP Audio - Portable System (Optional)
High-quality waterproof 50-watt Bluetooth† portable sound system.



Handlebar With Adjustable Riser
A telescopic steering system that optimizes the experience for varying rider sizes.



Extended Range VTS™ (Variable Trim System)
Offers double the range of the regular VTS™ for greater ease when executing tricks.



Step Wedges
Provides enhanced stability and confidence in different riding positions, making it easier to pull off tricks like a pro.



iBR® (Intelligent Brake & Reverse)
Exclusive to Sea-Doo®, iBR® stops the watercraft sooner and provides more control and maneuverability at low speeds and in reverse.



Exclusive Color and Graphics
Exclusive Trixx™ bold colors and graphics.

*Electronic brake, neutral and reverse. **May not be available at the time of purchase. Please check with your dealer.

†Bluetooth is a registered trademark owned by Bluetooth SIG, Inc. and any use of such trademarks by BRP is under license.

GTI™ 90/130

Style, stability and some serious fun.

GTI™ 90/130

KEY FEATURES

- Large swim platform with LinQ attachment system
- Ergolock™ two-piece seat
- Large front storage
- iBR® – Intelligent Brake & Reverse*
- Watertight phone compart^{ment}



White & Reef Blue

CAPACITY

Rider Capacity	3
Weight Capacity	272 kg
Fuel Capacity	60 L
Glove Box	8.8 L
Front Bin	144 L
Storage Capacity - Total	152.8 L

DIMENSIONS

Length (bumper to bumper)	331.8 cm
Width	125 cm
Height	113.7 cm

HULL

Type	GTI™ Hull
Material	Polytec™ Gen II

OTHER FEATURES

- Seat strap
- RF D.E.S.S.™ key**
- BRP Audio - premium system (accessory)
- Wide-angle mirrors
- Handle grips with palm rest
- Footwell carpet
- Swim platform carpet
- Tow hook

ROTAX® ENGINE	900 ACE™ - 90	1630 ACE™ - 130
Model	GTI 90	GTI 130
Intake System	Naturally aspirated	
Displacement	899 cc	1,630 cc
Cooling	Closed-Loop Cooling System (CLCS)	
Reverse System	Electronic iBR**	
Fuel Type	95 octane	
Throttle System	iTC™ (Intelligent Throttle Control)	
Exhaust System	D-Sea-Bel™ system	

GAUGE

Type of Gauge	4.5" digital display	
Main Functions	• Speedometer • RPM	• Clock • Vehicle hour display
iTC System - Mode	• Sport Mode	• ECO® Mode

WEIGHT

Dry Weight	303 kg	335 kg
------------	--------	--------

WARRANTY

BRP limited warranty covers the watercraft for two years.

FEATURE HIGHLIGHTS



iBR® (Intelligent Brake & Reverse)
Exclusive to Sea-Doo®, iBR® stops the watercraft sooner and provides more control and maneuverability at low speeds and in reverse.



Swim Platform with Integrated LinQ™ System
Exclusive quick-attach system on a large swim platform that allows for easy installation of accessories.



ECO® Mode
This exclusive Sea-Doo® feature optimizes power output for up to 46% improved fuel efficiency.



ROTAX® 900 ACE™ - 90/1630 ACE™ - 130
The Rotax® 900 ACE™ - 90 gives crisp acceleration with impressive fuel economy. And for those who want added performance, the extra horsepower of the 1630 ACE™ - 130 is all about fun and acceleration.

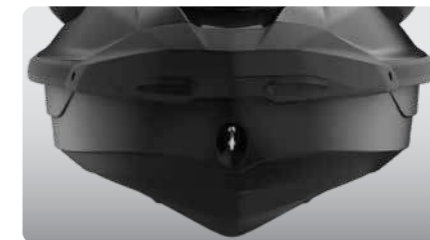

GTI Hull
This moderate V-shaped hull guarantees a stable, enjoyable ride in variable water conditions. Confident, predictable handling but incredibly playful when you want it to be.



Large Front Storage
An impressive 143 L of sealed storage space allows riders to safely stow belongings while riding.

*Electronic brake, neutral and reverse.
**May not be available at the time of purchase. Please check with your dealer.

GTI™ SE 130 / 170

Morw convenience and comfort for days of family fun.

KEY FEATURES

- BRP Audio - premium system (optional)
- iDF Intelligent Debris-Free Pump System (optional)
- Boarding ladder
- iBR® - Intelligent Brake & Reverse
- Variable Trim System (VTS™)
- Slow mode/speed regulator
- Two color options



- NEW Coral Blast & Eclipse Black
- Neon Yellow

CAPACITY

Rider Capacity	3
Weight Capacity	272 kg
Fuel Capacity	60 L
Glove Box	8.8 L
Front Bin	144 L
Storage Capacity - Total	152.8 L

DIMENSIONS

Length (bumper to bumper)	331.8 cm
Width	125 cm
Height	113.7 cm

HULL

Type	GTI™ Hull
Material	Polytec™ Gen II

OTHER FEATURES

- Ergolock™ two-piece seat
- Seat strap
- RF D.E.S.S.™ key**
- Large front storage
- Watertight phone compartent
- LinQ™ attachment system
- Wide-angle mirrors
- Handle grips with palm rest
- Footwell carpets
- Large swim platform with carpet
- Tow hook

ROTAX® ENGINE

	1630 ACE™ - 130	1630 ACE™ - 170
Model	GTI SE 130	GTI SE 170
Intake System	Naturally aspirated	
Displacement	1,630 cc	
Cooling	Closed-Loop Cooling System (CLCS)	
Reverse System	Electronic iBR®	
Fuel Type	95 octane	
Throttle System	iTC™ (Intelligent Throttle Control) system	
Exhaust System	D-Sea-Bel™ system	

GAUGE

Type of Gauge	4.5" digital display	
Main Functions	• Speedometer • RPM • Clock	• VTS™ display • Vehicle hour display
iTC System - Mode	• Sport mode • ECO® mode	• Slow mode • Speed regulator

WEIGHT

Dry Weight	335 kg
------------	--------

WARRANTY

BRP limited warranty covers the watercraft for two years.

GTI™ SE 130 / 170



GTI™ SE 170

- Neon Yellow



GTI™ SE 130

- NEW Coral Blast & Eclipse Black

FEATURE HIGHLIGHTS



BRP Audio - Premium System (Optional)
An industry-first manufacturer-installed truly waterproof Bluetooth® audio system.



Swim Platform with Integrated LinQ™ System
Exclusive quick-attach system on a large swim platform that allows for easy installation of accessories.



iDF - Intelligent Debris-Free Pump System (Optional)
An innovative, industry-first system that allows you to free your pump of weeds and debris with intuitive handlebar-activated controls.



ROTAX® 1630 ACE™ - 130 / 170
Enjoy plenty of pep with the 1630 ACE™ - 100 kW (130 hp) or opt for the 125 kW (170 hp) version –the most powerful naturally aspirated Rotax engine ever on a Sea-Doo watercraft.



Boarding Ladder
Makes boarding from the water easier and quicker.



Large Front Storage
An impressive 143 L of sealed storage space allows riders to safely stow belongings while riding.

*Electronic brake, neutral and reverse.

**May not be available at the time of purchase. Please check with your dealer.

WAKE™ 170

Made to make the most of the wake.

KEY FEATURES

- BRP Audio - premium system (optional)
- Large front storage
- Watertight phone compart^{ment}
- Boarding ladder
- iBR® - Intelligent Brake & Reverse*
- WAKE Package:
 - LinQ retractable ski pylon
 - Speed-based ski mode
 - Removable wakeboard rack
 - WAKE™ graphics



NEW Neo Mint

CAPACITY

Rider Capacity	3
Weight Capacity	272 kg
Fuel Capacity	60 L
Glove Box	8.8 L
Front Bin	144 L
Storage Capacity - Total	152.8 L

DIMENSIONS

Length (bumper to bumper)	331.8 cm
Width	125 cm
Height	113.7 cm

HULL

Type	GTI™ Hull
Material	Polytec™ Gen II

OTHER FEATURES

- Ergolock™ two-piece touring seat
- Seat strap
- VTS™ - Variable Trim System
- RF D.E.S.S.™ key**
- LinQ™ attachment system
- Wide-angle mirrors
- Handlegrip with palm rests
- Footwell carpets
- Large swim platform with carpet
- Tow hook

ROTAX® ENGINE

1630 ACE™ - 170

Intake System	Naturally aspirated
Displacement	1,630 cc
Cooling	Closed-Loop Cooling System (CLCS)
Reverse System	Electronic iBR
Fuel Type	95 Octane
Throttle System	iTC™ (Intelligent Throttle Control)
Exhaust System	D-Sea-Bel™ system

GAUGE

Type of Gauge	4.5" digital display	
Main Functions	<ul style="list-style-type: none"> • Speedometer • RPM • Clock 	<ul style="list-style-type: none"> • VTS™ • Fuel autonomy • Vehicle hours
iTC System - Mode	<ul style="list-style-type: none"> • Sport mode • ECO* mode • Slow mode 	<ul style="list-style-type: none"> • Speed regulator • Ski mode

WEIGHT

Dry Weight	339 kg
------------	--------

WARRANTY

BRP limited warranty covers the watercraft for 2 years.

*Electronic brake, neutral and reverse.
**May not be available at the time of purchase. Please check with your dealer.

WAKE™ 170

FEATURE HIGHLIGHTS



Ski Mode
Five preset acceleration profiles make it easy to deliver a smooth launch and maintain consistent pace.



LinQ™ Retractable Ski Pylon
A quick install retractable ski pylon that stows away when not in use. Features spotter hand grips and rope storage.



Wakeboard Rack
Provides easy transport of a wakeboard.¹



ROTAX® 1630 ACE™ - 170
The new Rotax® 1630 ACE™ - 170 is the most powerful naturally aspirated Rotax engine ever on a Sea-Doo watercraft.



BRP Audio - Premium System (Optional)
An industry-first manufacturer-installed, truly waterproof, Bluetooth[®] audio system.



Watertight Phone Compartment
Waterproof and shockproof compartment specifically designed for phone protection.³

¹ Wakeboard and rope not included. ² Cell phone is not included.

WAKE™ PRO 230

Stability, power and music to tow like a pro.

KEY FEATURES

- NEW Full-color 7.8" wide display
- BRP Audio – premium system
- Direct-access front storage
- Watertight phone compartment
- iBR® – Intelligent Brake & Reverse*
- Boarding ladder
- WAKE Package:
 - LinQ retractable ski pylon
 - Speed-based ski mode
 - Removable wakeboard rack
 - WAKE™ graphics



NEW Neo Mint

CAPACITY

Rider Capacity	3
Weight Capacity	272 kg
Fuel Capacity	70 L
Glove Box	2.9 L
Front Bin	96 L
Storage Capacity - Total	98.9 L

DIMENSIONS

Length (bumper to bumper)	345.1 cm
Width	125.5 cm (w/o rack)
Height	114 cm

HULL

Type	ST3 Hull™
Material	Fiberglass

OTHER FEATURES

- Ergolock™ two-piece seat
- Seat strap
- VTS™ - Variable Trim System
- RF D.E.S.S.™ key**
- LinQ™ attachment system
- Wide-angle mirrors
- Handlegrip with palm rests
- Footwell carpets
- Large swim platform with carpet
- Tilt steering
- Ski tow eye

ROTAX® ENGINE

1630 ACE™ - 230

Intake System	Supercharged with external intercooler
Displacement	1,630 cc
Cooling	Closed-Loop Cooling System (CLCS)
Reverse System	Electronic iBR
Fuel Type	95 octane
Throttle System	iTC™ (Intelligent Throttle Control)
Exhaust System	D-Sea-Bel™ system

GAUGE

Type of Gauge	Large panoramic 7.8" wide LCD display	
Main Functions	• BRP Connect **	• Clock
	• Music **	• VTS™
Main Functions	• Weather **	• Fuel consumption
	• Bluetooth connectivity	• Fuel autonomy
	• Speedometer	• Water temperature
	• RPM	• Vehicle hours
iTC System - Mode	• Sport mode	• Speed regulator
	• ECO® mode	• Ski mode
	• Slow mode	

WEIGHT

Dry Weight	376 kg
------------	--------

WARRANTY

BRP limited warranty covers the watercraft for two years.

*Electronic brake, neutral and reverse. **May not be available at the time of purchase. Please check with your dealer.

WAKE™ PRO 230

FEATURE HIGHLIGHTS



NEW Full-Color 7.8" Wide Display

Full-color display with incredible visibility and a new level of functionality. Bluetooth and smartphone app integration provides music, weather, navigation and more.



BRP Audio – Premium System

An industry-first manufacturer-installed, truly waterproof, Bluetooth¹ audio system.



Wakeboard Rack

Provides convenient storage and transport of a wakeboard.¹



ROTAX® 1630 ACE™ – 230 Engine

This powerful engine comes standard with a supercharger and external intercooler. It is optimized to run on regular fuel, which lowers fuel costs.



ST3 Hull™

An innovative hull that sets the benchmark for rough water handling, stability, and offshore performance.



LinQ™ Retractable Ski Pylon

A quick-install retractable ski pylon that stows away when not in use. Features spotter handgrips and rope storage.

¹Wakeboard and rope not included.

GTX™ PRO 130

Rental model.



KEY FEATURES

- LinQ™ attachment system
- 70 L fuel tank capacity
- Boarding ladder
- Direct-access front storage
- iBR® – Intelligent Brake & Reverse* (optional)
- Watertight phone compart^{ment}
- Heavy-duty parts: electrical harness, handlegrips, seat, wear ring, drive shaft and impeller



White & Reef Blue

CAPACITY

Rider Capacity	3
Weight Capacity	272 kg
Fuel Capacity	70 L
Glove Box	2.9 L
Front Bin	96 L
Storage Capacity - Total	98.9 L

DIMENSIONS

Length (bumper to bumper)	345.1 cm
Width	125.5 cm
Height	114 cm

HULL

Type	ST3 Hull™
Material	Fiberglass

OTHER FEATURES

- Heavy-duty seat with thermoformed vinyl
- Seat strap
- RF D.E.S.S.™ key**
- Wide-angle mirrors
- Handle grips with palm rest
- Footwell carpets
- Large swim platform with carpet
- Tow hook

ROTAX® ENGINE

1630 ACE™ - 130	
Intake System	Naturally aspirated
Displacement	1,630 cc
Cooling	Closed-Loop Cooling System (CLCS)
Reverse System	Electronic iBR® (optional)
Fuel Type	95 octane
Throttle System	iTC™ (Intelligent Throttle Control)
Exhaust System	D-Sea-Bel™ system

GAUGE

Type of Gauge	4.5" digital display	
Main Functions	• Speedometer	• Vehicle hours
	• RPM	
iTC System - Mode	• Sport mode	• ECO® mode

WEIGHT

Dry Weight	356 kg
------------	--------

WARRANTY

BRP limited warranty covers the watercraft for 6 months.

GTX™ PRO 130

FEATURE HIGHLIGHTS



Heavy-Duty Components
Heavy-duty wear ring, wiring harness, seat, handlegrips, drive shaft and impeller designed to last longer.



ECO® Mode
This exclusive Sea-Doo® feature optimizes power output for up to 46% improved fuel efficiency.



iBR® (Intelligent Brake & Reverse) (Optional)
Exclusive to Sea-Doo®, iBR® stops the watercraft sooner and provides more control and maneuverability at low speeds and in reverse.



ROTAX® 1630 ACE™ - 130 Engine
The powerful and reliable naturally aspirated 1630 ACE™ - 130 is all about fun and acceleration while providing excellent fuel efficiency.



ST3 Hull™
Stable and predictable for a versatile, safe and smooth ride in moderate and rough water conditions.²



Boarding Ladder
Makes boarding from the water easier and quicker.

*Electronic brake, neutral and reverse.

**May not be available at the time of purchase. Please check with your dealer.

GTX™ 170 / 230

Comfort, control and power are always in style.

GTX™ 170 / 230



KEY FEATURES

- iDF - Intelligent Debris-Free Pump System (Optional on GTX 230 model)
- BRP Audio – premium system
- Direct-access front storage
- Watertight phone compartment
- LinQ™ attachment system
- iBR® – Intelligent Brake & Reverse*
- Boarding ladder
- VTS™ - Variable Trim System

Eclipse Black & Orange Crush

CAPACITY

Rider Capacity	3
Weight Capacity	272 kg
Fuel Capacity	70 L
Glove Box	2.9 L
Front Bin	96 L
Storage Capacity - Total	98.9 L

DIMENSIONS

Length (bumper to bumper)	345.1 cm
Width	125.5 cm
Height	113.8 cm

HULL

Type	ST3 Hull™
Material	Fiberglass

OTHER FEATURES

- Ergolock™ two-piece seat w/ stepped design
- Seat strap
- RF D.E.S.S.™ key**
- Wide-angle mirrors
- Handle grips with palm rest
- Footwell carpets
- Large swim platform with carpet
- Tilt steering
- Ski tow eye

ROTAX® ENGINE

	1630 ACE™ - 170	1630 ACE™ - 230
Model	GTX® 170	GTX® 230
Intake System	Naturally aspirated	Supercharged with external intercooler
Displacement	1,630 cc	
Cooling	Closed-Loop Cooling System (CLCS)	
Reverse System	Electronic iBR®	
Fuel Type	95 octane	95 octane
Throttle System	iTC™ (Intelligent Throttle Control)	
Exhaust System	D-Sea-Bel™ system	

GAUGE

Type of Gauge	7.6" wide digital display	
Main Functions	<ul style="list-style-type: none"> • Speedometer • RPM • Clock • VTS™ 	<ul style="list-style-type: none"> • Fuel consumption • Fuel autonomy • Vehicle hours
iTC System - Mode	<ul style="list-style-type: none"> • Sport mode • ECO® mode 	<ul style="list-style-type: none"> • Slow mode • Speed regulator

WEIGHT

Dry Weight	352 kg	365 kg
------------	--------	--------

WARRANTY

BRP limited warranty covers the watercraft for two years.

FEATURE HIGHLIGHTS



iDF – Intelligent Debris-Free Pump System (Optional)
An innovative, industry-first system that allows you to free your pump of weeds and debris with intuitive handlebar-activated controls.



BRP Audio - Premium System (Optional)
An industry-first manufacturer-installed truly waterproof Bluetooth¹ audio system.



Direct-Access Front Storage
Large front storage area that's easily accessible from a seated position.¹

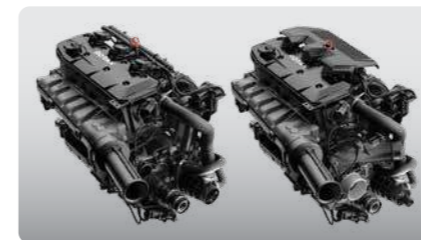

ROTAX® 1630 ACE™ - 170 / 230
The Rotax® 1630 ACE engine block is offered in three configurations on this versatile platform. The 125 kW (170 hp) boasts naturally aspirated punch with optimal fuel economy. The 169 kW (230 hp) supercharged version allows you to level up the performance to your liking.



ST3 Hull™
An innovative hull that sets the benchmark for rough water handling, stability, and offshore performance.



Swim Platform with Integrated LinQ™ System
Exclusive quick-attach system on the largest swim platform in the industry allows for easy installation of storage accessories.

*Electronic brake, neutral and reverse.

**May not be available at the time of purchase. Please check with your dealer.

¹ Larger storage front bin organizer is not included.



GTX™ LIMITED 300

The standard for high-end touring performance.

KEY FEATURES

- Rotax 1630 ACE – 300 engine
- BRP Audio – premium system
- Full-color 7.8" wide display
- iDF – Intelligent Debris Free Pump System
- Direct-access front storage
- Limited Package:
 - USB port
 - Protective Cover
 - Storage bin organizer
 - Knee pads
 - Depth finder
 - Exclusive coloration and more



-  NEW Premium Metallic Sage
-  NEW Liquid Titanium & Black

CAPACITY

Rider Capacity	
Weight Capacity	272 kg
Fuel Capacity	70 L
Glove Box	2.9 L
Front Bin	96 L
Storage Capacity - Total	98.9 L

DIMENSIONS

Length (bumper to bumper)	345.1 cm
Width	125.5 cm
Height	114 cm

HULL

Type	ST3 Hull™
Material	Fiberglass

OTHER FEATURES

- Ergolock™ two-piece seat w/stepped design
- Seat strap
- iBR – Intelligent Brake & Reverse
- VTS™ - Variable Trim System
- Boarding ladder
- RF D.E.S.S.™ key**
- Watertight phone compartment
- LinQ™ attachment system
- Knee pads
- Wide-angle mirrors
- Handle grips with palm rest
- Footwell carpets
- Large swim platform with carpet
- Tilt steering
- Ski tow eye

ROTAX® ENGINE

1630 ACE™ - 230

Model	GTX 300
Intake System	Supercharged with external intercooler
Displacement	1,630 cc
Cooling	Closed-Loop Cooling System (CLCS)
Reverse System	Electronic iBR® *
Fuel Type	98 octane
Throttle System	iTC™ (Intelligent Throttle Control)
Exhaust System	D-Sea-Bel™ system

GAUGE

Type of Gauge	Large panoramic 7.8" wide LCD display	
Main Functions	• BRP Connect **	• VTS™
	• Music **	• Fuel consumption
iTC System - Mode	• Weather **	• Fuel autonomy
	• Bluetooth connectivity	• Water temperature
	• Speedometer	• Depth finder
	• RPM	• Speed statistics
	• Clock	• Vehicle hours
	• Sport mode	• Slow mode
	• ECO® mode	• Speed regulator

WEIGHT

Dry Weight	385 kg
------------	--------

WARRANTY

BRP limited warranty covers the watercraft for two years.

GTX™ LIMITED 300



 NEW Liquid Titanium & Black

FEATURE HIGHLIGHTS



iDF – Intelligent Debris-Free Pump System

An innovative, industry-first system that allows you to free your pump of weeds and debris with intuitive handlebar-activated controls.



BRP Audio - Premium System

The industry's first manufacturer-installed truly waterproof Bluetooth® audio system.



Full-Color 7.8" Wide Display

Full-color display with incredible visibility and a new level of functionality. Bluetooth and smartphone app integration provides music, weather, navigation and more.



ROTAX® 1630 ACE™ - 300

The Rotax® 1630 ACE – 230 offers instant acceleration by way of a powerful supercharger, while the new Rotax® 1630 ACE™ – 300 is the most powerful Rotax engine ever on a Sea-Doo.



ST3 Hull™

An innovative hull that sets the benchmark for rough water handling, stability, and offshore performance.



Swim Platform with Integrated LinQ™ System

Exclusive quick-attach system on the largest swim platform in the industry allows for easy installation of storage accessories.

*Electronic brake, neutral and reverse.

**May not be available at the time of purchase. Please check with your dealer.

NEW FISHPRO™ Scout 130

Accessible, versatile and all-around fun.

KEY FEATURES

- iDF - Intelligent Debris-Free Pump System
- Ergolock™ two-piece fishing seat
- 3 fishing rod holders
- Garmin® 6" GPS & Fish Finder
 - Includes free regional map token
- LinQ™ fishing cooler (51 L)
- Trolling Mode (slow mode)
- Front storage lid organizer
- 2 LinQ front supports
- Cup holder



 White & Gulfstream Blue

CAPACITY

Rider Capacity	
Weight Capacity	272 kg
Fuel Capacity	60 L
Glove Box	8.8 L
Front Bin	144 L
LinQ™ Fishing Cooler	51 L
Storage Capacity - Total	203.8 L

DIMENSIONS

Length (bumper to bumper)	331.8 cm
Width	125 cm
Height	117 cm

HULL

Type	GTI™ hull
Material	Polytec™ Gen II

OTHER FEATURES

- Seat strap
- iBR – Intelligent Brake & Reverse
- VTS™ (Variable Trim System)
- Boarding ladder
- RF D.E.S.S.™ key**
- Watertight phone compart^{ment}
- LinQ™ attachment system
- Wide-angle mirrors
- Handle grips with palm rest
- Footwell carpets
- Large swim platform with carpet
- Tow hook

ROTAX® ENGINE

1630 ACE™ - 130

Intake System	Naturally aspirated
Displacement	1,630 cc
Cooling	Closed-Loop Cooling System (CLCS)
Reverse System	Electronic iBR**
Fuel Type	95 octane
Throttle System	iTC™ (Intelligent Throttle Control)
Exhaust System	D-Sea-Bel™ system

GAUGE

Type of Gauge	4.5" digital display
Main Functions	<ul style="list-style-type: none"> • Speedometer • RPM • Clock • VTS™ display • Fuel autonomy • Water temperature • Vehicle hours
iTC System - Mode	<ul style="list-style-type: none"> • Sport mode • ECO® mode • Trolling Mode (slow mode) • Speed regulator

WEIGHT

Dry Weight	355 kg
------------	--------

WARRANTY

BRP limited warranty covers the watercraft for two years.

FISHPRO™ Scout 130

FEATURE HIGHLIGHTS



iDF - Intelligent Debris-Free Pump System

An innovative, industry-first system that allows you to free your pump of weeds and debris with intuitive handlebar-activated controls.



Garmin® 6" GPS & Fish Finder

A top-of-the-line navigation, charting and fish-finding system using an in-hull transducer and mid-CHIRP sonar. Includes token for access to free upgraded regional maps.



LinQ™ Fishing Cooler & Fishing Rod Holders

A spacious, quick-attach fishing cooler designed for easy access and equipped with numerous convenient features.



Fishing Bench Seat

Designed for easier movement from front to rear and from side to side.



Front Storage Organizer

Easily store tackle and other small items in this conveniently located organizer.



Trolling Mode

Enables precise control of speed. Choose one of several pre-sets and adjust as needed.

**Electronic brake, neutral and reverse

**May not be available at the time of purchase. Please check with your dealer.

FISHPRO™ Sport 170

The original game-changer.
Find yourself a new perspective
on sport fishing.

KEY FEATURES

- iDF - Intelligent Debris-Free Pump System
- Extended rear platform with second LinQ™ attachment system
- Garmin® 6" GPS & Fish Finder
- Includes free regional map token
- LinQ fishing cooler (51 L)
- 5 fishing rod holders
- Angled gunwale footrests
- BRP Audio – premium system (optional)
- Direct access front storage with bin organizer



 White & Gulfstream Blue

CAPACITY

Rider Capacity	
Weight Capacity	272 kg
Fuel Capacity	70 L
Glove Box	2.9 L
Front Bin	96 L
LinQ™ Fishing Cooler	51 L
Storage Capacity - Total	149.9 L

DIMENSIONS

Length (bumper to bumper)	373 cm
Width	125 cm
Height	115 cm

HULL

Type	ST3 Hull™
Material	Fiberglass

OTHER FEATURES

- Ergolock two-piece fishing seat
- Seat strap
- iBR – Intelligent Brake & Reverse
- VTS™ (Variable Trim System)
- Boarding ladder
- RF D.E.S.S.™ key**
- Watertight phone compartment
- Wide-angle mirrors
- Handle grips with palm rest
- Footwell carpets
- Large swim platform with carpet
- 2 LinQ front supports
- Cup holder
- USB port
- Tilt steering
- Ski tow eye

ROTAX® ENGINE

1630 ACE™ - 170

Intake System	Naturally aspirated
Displacement	1,630 cc
Cooling	Closed-Loop Cooling System (CLCS)
Reverse System	Electronic iBR**
Fuel Type	95 octane
Throttle System	iTC™ (Intelligent Throttle Control)
Exhaust System	D-Sea-Bel™ system

GAUGE

Type of Gauge	7.6" wide digital display	
Main Functions	<ul style="list-style-type: none"> • Speedometer • RPM • Clock • VTS™ 	<ul style="list-style-type: none"> • Fuel autonomy • Water temperature • Vehicle hours
iTC System - Mode	<ul style="list-style-type: none"> • Sport mode • ECO® mode 	<ul style="list-style-type: none"> • Trolling Mode (slow mode) • Speed regulator

WEIGHT

Dry Weight	389 kg
------------	--------

WARRANTY

BRP limited warranty covers the watercraft for two years.



FEATURE HIGHLIGHTS



iDF - Intelligent Debris-Free Pump System

An innovative, industry-first system that allows you to free your pump of weeds and debris with intuitive handlebar-activated controls.



Garmin® 6" GPS & Fish Finder

A top-of-the-line navigation, charting and fish-finding system using an in-hull transducer and mid-CHIRP sonar. Includes token for access to free upgraded regional maps.



LinQ™ Fishing Cooler & Fishing Rod Holders

A spacious, quick-attach fishing cooler designed for easy access and equipped with numerous convenient features.



Extended Rear Platform with Second LinQ™ Attachment System

Adds 11.5 inches to the back of the watercraft to increase stability, space, and storage capability.



Angled Gunwale Footrests

Ensures ergonomic and secure posture while fishing from a side position.



Trolling Mode

Enables precise control of speed. Choose one of several pre-sets and adjust as needed.

*Electronic brake, neutral and reverse.

**May not be available at the time of purchase. Please check with your dealer.

NEW FISHPRO™ Trophy 170

The most advanced sport fishing personal watercraft on the water.

KEY FEATURES

- iDF - Intelligent Debris-Free Pump System
- Advanced battery system
- LinQ™ fishing cooler (51 L)
- Quick-connect livewell
- Garmin† 7" touchscreen GPS & Fish Finder
 - Includes free regional map token
- NEW Tech Package: BRP Audio – premium system & full-color 7.8" wide display (optional)



NEW Shark Grey & Orange Crush

CAPACITY

Rider Capacity	3
Weight Capacity	272 kg
Fuel Capacity	70 L
Glove Box	2.9 L
Front Bin	96 L
LinQ™ Fishing Cooler	51 L
Storage Capacity - Total	149.9 L

DIMENSIONS

Length (bumper to bumper)	373 cm
Width	125 cm
Height (pedestal seat uninstalled)	115 cm

HULL

Type	ST3 Hull™
Material	Fiberglass

OTHER FEATURES

- Seat strap
- iBR – Intelligent Brake & Reverse
- VTS™ - Variable Trim System
- Boarding ladder
- RF D.E.S.S.™ key**
- Direct-access front storage
- Storage bin organizer
- Watertight phone compartment
- Two sets of LinQ™ attachment points
- Wide-angle mirrors
- Handle grips with palm rest
- Footwell carpets
- Large swim platform with carpet
- 5 fishing rod holders
- Angled gunwale footrests
- Integrated washdown
- Extended rear platform
- 2 LinQ front supports
- Cup holder
- USB port
- Tilt steering
- Ski tow eye

ROTAX® ENGINE

1630 ACE™ - 170	
Intake System	Naturally aspirated
Displacement	1,630 cc
Cooling	Closed-Loop Cooling System (CLCS)
Reverse System	Electronic iBR**
Fuel Type	95 octane
Throttle System	iTC™ (Intelligent Throttle Control)
Exhaust System	D-Sea-Bel™ system

GAUGE

Type of Gauge	Large panoramic 7.8" wide LCD display (Opt. w/ audio) 7.6" wide digital display (w/o audio)
Main Functions	<ul style="list-style-type: none"> • BRP Connect (opt.)** • Music (opt.)** • Weather (opt.)** • Bluetooth compatible (opt.) • Speedometer • RPM • Clock • VTS™ • Fuel consumption (opt. w/ audio) • Fuel autonomy • Water temperature • Speed statistics (opt. w/ audio) • Vehicle hours
iTC System - Mode	<ul style="list-style-type: none"> • Sport mode • ECO® mode • Trolling Mode (slow mode) • Speed regulator

WEIGHT

Dry Weight	407 kg
------------	--------

WARRANTY

BRP limited warranty covers the watercraft for two years.

*Electronic brake, neutral and reverse.
**May not be available at the time of purchase. Please check with your dealer.

FISHPRO™ Trophy 170

FEATURE HIGHLIGHTS



Anchoring System

Allows quick access and easy storage of the anchor. It also keeps your front storage neat by eliminating the need to store a rope and anchor there.



Garmin† 7" Touchscreen GPS & Fish Finder

A large 7" touchscreen top-of-the-line navigation, charting and fish-finding system using an in-hull transducer and mid-CHIRP sonar. Includes token for access to free upgraded regional maps



Quick-Connect Livewell

Turn the LinQ Fishing Cooler into a livewell in seconds. An integrated pump constantly feeds fresh water into the reservoir keeping your catch or your bait alive all day.



Modular Swivel Seat *

Brings flexibility to the fisherman to comfortably cast and jig for longer period from a more upright position. Installs and stows in seconds.

* only available in North America



Advanced Battery System

With dual batteries and a 650-watt voltage generator, even the most demanding electrical needs are sure to be met.



Full-Color 7.8" Wide Display (Optional)

Full-color display with incredible visibility and a new level of functionality. Bluetooth and smartphone app integration provides music, weather, navigation and more.

GTR™ 230

Accessible power and performance.

KEY FEATURES

- ROTAX® 1630 ACE™ - 230 engine
- BRP Audio - premium system (optional)
- Large front storage
- Watertight phone compart^{ment}
- LinQ™ attachment system
- VTS™ - Variable Trim System



● NEW Millennium Yellow

CAPACITY

Rider Capacity	3
Weight Capacity	272 kg
Fuel Capacity	60 L
Glove Box	8.8 L
Front Bin	152 L
Storage Capacity - Total	160.8 L

DIMENSIONS

Length (bumper to bumper)	331.8 cm
Width	125 cm
Height	113.7 cm

HULL

Type	GTI Hull
Material	Polytec™ Gen II

OTHER FEATURES

- Ergolock™ two-piece touring seat
- Seat strap
- iBR - Intelligent Brake & Reverse
- RF D.E.S.S.™ key**
- Wide-angle mirrors
- Handle grips with palm rest
- Footwell carpets
- Large swim platform with carpet
- Tow hook

ROTAX® ENGINE

1630 ACE™ - 230

Intake System	Supercharged with external intercooler
Displacement	1,630 cc
Cooling	Closed-Loop Cooling System (CLCS)
Reverse System	Electronic iBR**
Fuel Type	95 octane
Throttle System	iTC™ (Intelligent Throttle Control)
Exhaust System	D-Sea-Bel™ system

GAUGE

Type of Gauge	4.5" digital display	
Main Functions	• Speedometer • RPM • Clock	• VTS™ • Fuel autonomy • Vehicle hours
iTC System - Mode	• Sport mode • ECO* mode	• Slow mode • Speed regulator

WEIGHT

Dry Weight	351 kg
------------	--------

WARRANTY

BRP limited warranty covers the watercraft for two years.

GTR™ 230

FEATURE HIGHLIGHTS



BRP Audio - Premium System (Optional)
The industry's first manufacturer-installed truly waterproof Bluetooth¹ audio system.



VTS™ (Variable Trim System)
Provides handlebar-activated settings so riders can easily find the ideal trim for varying conditions.



Swim Platform with Integrated LinQ™ System
Exclusive quick-attach system on a large swim platform that allows for easy installation of storage accessories.



ROTAX® 1630 ACE™ - 230 Engine
This powerful engine comes standard with a supercharger and external intercooler. It is optimized to run on regular fuel, which lowers fuel costs.

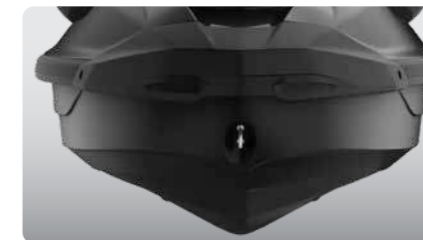

GTI Hull
This moderate V-shaped hull guarantees a stable, enjoyable ride in variable water conditions. Confident, predictable handling but incredibly playful when you want it to be.



Large Front Storage
An impressive 152 L of sealed storage space allows riders to safely stow belongings while riding.

*Electronic brake, neutral and reverse.

**May not be available at the time of purchase. Please check with your dealer.

RXP[®]-X[®] RS 300

Race-ready performance watercraft, reimagined.

KEY FEATURES

- Rotax 1630 ACE – 300 engine
- Ergolock™ R racing seat
- T3-R hull
- **NEW Tech Package:** BRP Audio – premium system & full-color 7.8" wide display (Optional)
- Launch control
- Low-rise racing handlebar
- Double-angled footwell wedges
- X-sponsons



- NEW **Premium** Triple Black
- Millennium Yellow

CAPACITY

Rider Capacity	2
Weight Capacity	182 kg
Fuel Capacity	70 L
Glove Box	9.7 L
Front Bin	143 L
Storage Capacity - Total	153.7 L

DIMENSIONS

Length (bumper to bumper)	331.8 cm
Width	125 cm
Height	111 cm

HULL

Type	T3-R Hull™
Material	Fiberglass

OTHER FEATURES

- iBR – Intelligent Brake & Reverse
- Extended VTS™ (Variable Trim System)
- RF D.E.S.S.™ key**
- Watertight phone compartment
- LinQ™ attachment system
- Wide-angle mirrors
- Round handle grips
- Footwell carpets
- Large swim platform with carpet
- Ski tow eye

ROTAX[®] ENGINE

1630 ACE™ - 300

Intake System	Supercharged with external intercooler
Displacement	1,630 cc
Cooling	Closed-Loop Cooling System (CLCS)
Reverse System	Electronic iBR**
Fuel Type	Minimum 95 Octane Recommended: 98 Octane
Throttle System	iTC™ (Intelligent Throttle Control)
Exhaust System	D-Sea-Bel™ system

GAUGE

Type of Gauge	Large panoramic 7.8" wide LCD display optional (w/audio) 7.6" wide digital display (w/o audio)
Main Functions	<ul style="list-style-type: none"> • BRP Connect (opt.)** • Music (opt.)** • Weather (opt.)** • Bluetooth connectivity (opt.) • Speedometer • RPM • Clock • VTS™ • Fuel consumption (opt.) • Fuel autonomy • Speed statistics • Vehicle hours
iTC System - Mode	<ul style="list-style-type: none"> • Sport mode • ECO[®] mode • Slow mode • Speed regulator • Launch control

WEIGHT

Dry Weight	354 kg
------------	--------

WARRANTY

BRP limited warranty covers the watercraft for two years.

*Electronic brake, neutral and reverse.
**May not be available at the time of purchase. Please check with your dealer.

RXP[®]-X[®] RS 300



● Millennium Yellow

FEATURE HIGHLIGHTS



ERGOLOCK™ R System
A narrow seat profile with deep knee pockets and a revolutionary adjustable saddle that allows riders to lock in to the machine like never before.



BRP Audio - Premium System (Optional)
The industry's first manufacturer-installed truly waterproof Bluetooth[®] audio system.²



Full-Color 7.8" Wide Display (Optional)
Full-color display with incredible visibility and a new level of functionality. Bluetooth and smartphone app integration provides music, weather, navigation and more.



ROTAX[®] 1630 ACE™ - 300 Engine
The Rotax 1630 ACE is the most powerful Rotax engine ever, delivering high efficiency and best-in-class acceleration.

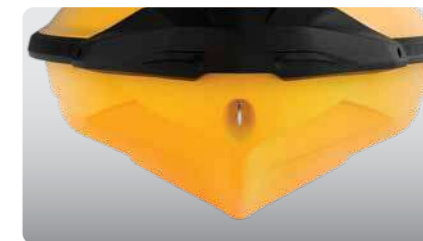

T3-R Hull™
A deep-V design that offers unrivaled handling and acceleration and a new level of control at high speed.



Large Front Storage
An impressive 143 L of sealed storage space allows riders to safely stow belongings while riding.

RXT®-X® RS 300

The ultimate off-shore performance watercraft.



KEY FEATURES

- Rotax 1630 ACE – 300 engine
- Ergolock two-piece racing seat
- ST3 hull
- NEW Tech Package: BRP Audio – premium system & full-color 7.8" wide display
- Launch control
- Tilt steering
- Full-length angled footwell wedges
- X-sponsons



- NEW *Premium* Triple Black
- Millennium Yellow

CAPACITY

Rider Capacity	3
Weight Capacity	272 kg
Fuel Capacity	70 L
Glove Box	2.9 L
Front Bin	96 L
Storage Capacity - Total	98.9 L

DIMENSIONS

Length (bumper to bumper)	345.1 cm
Width	125.5 cm
Height	114.7 cm

HULL

Type	ST3 Hull™
Material	Fiberglass

OTHER FEATURES

- Seat strap
- iBR – Intelligent Brake & Reverse
- Extended VTS™ (Variable Trim System)
- RF D.E.S.S.™ key**
- Watertight phone compartment
- LinQ™ attachment system
- Knee pads
- Wide-angle mirrors
- Handle grips with palm rest
- Footwell carpets
- Large swim platform with carpet
- Ski tow eye

ROTAX® ENGINE

1630 ACE™ - 300

Intake System	Supercharged with external intercooler
Displacement	1,630 cc
Cooling	Closed-Loop Cooling System (CLCS)
Reverse System	Electronic iBR®*
Fuel Type	Minimum: 95 Octane Recommended: 98 Octane
Throttle System	iTC™ (Intelligent Throttle Control)
Exhaust System	D-Sea-Bel™ system

GAUGE

Type of Gauge	Large panoramic 7.8" wide LCD display optional
Main Functions	<ul style="list-style-type: none"> • BRP Connect (opt.)** • Music (opt.)** • Weather (opt.)** • Bluetooth connectivity • Speedometer • RPM • Clock • VTS™ • Fuel consumption • Fuel autonomy • Speed statistics • Vehicle hours
iTC System - Mode	<ul style="list-style-type: none"> • Sport mode • ECO* mode • Slow mode • Speed regulator • Launch control

WEIGHT

Dry Weight	376 kg
------------	--------

WARRANTY

BRP limited warranty covers the watercraft for two years.

*Electronic brake, neutral and reverse.
**May not be available at the time of purchase. Please check with your dealer.
†Bluetooth is a registered trademark owned by Bluetooth SIG, Inc. and any use of such trademarks by BRP is under license.

RXT®-X® RS 300



● Millennium Yellow

FEATURE HIGHLIGHTS



Ergolock™ System
A narrow seat profile with deep knee pockets lets riders sit naturally and use the lower body to hold onto the machine for more control.



BRP Audio - Premium System
The industry's first manufacturer-installed truly waterproof Bluetooth[†] audio system.³



Full-Color 7.8" Wide Display
Full-color display with incredible visibility and a new level of functionality. Bluetooth and smartphone app integration provides music, weather, navigation and more.



ROTAX® 1630 ACE™ - 300 Engine
The Rotax 1630 ACE – 300 is the most powerful Rotax engine ever, delivering high efficiency and best-in-class acceleration.



ST3 Hull™
An innovative hull that sets the benchmark for rough water handling, stability, and offshore performance.



Direct-Access Front Storage
Large front storage area that's easily accessible from a seated position.¹









¹ Bin organizers are not included.

Comparative Chart

	REC LITE			RECREATION				
	SPARK®		SPARK® TRIXX™	GTI™		GTI™ SE		
	One-of-a-kind fun.			Playful trickster.				
MODELS	SPARK® 2up Rotax® 900 ACE™ - 60	SPARK® 2UP Rotax® 900 ACE™ - 90	SPARK® 3UP Rotax® 900 ACE™ - 90	SPARK® TRIXX™ 2up	SPARK® TRIXX™ 3up			
COLORS	NEW Orange Crush & Lava Red		NEW Dazzling Blue & Deep Black	White & Reef Blue		NEW Coral Blast & Eclipse Black		
	NEW Reef Blue & Manta Green		Lava Red & Deep Black			Neon Yellow		
	Key features							
	<ul style="list-style-type: none"> Lightweight and playful platform Able to tow with most mid-size cars Up to 3 passengers <p>Convenience Plus Package (optional with 900 ACE - 90 only):</p> <ul style="list-style-type: none"> iBR - Intelligent Brake & Reverse BRP Audio - portable system (optional with 3up Convenience Package only) Front storage bin kit Boarding step RF D.E.S.S.™ key 		<ul style="list-style-type: none"> Lightweight and playful platform Able to tow with most mid-size cars Up to 3 passengers BRP Audio - portable system (optional) <p>TRIXX Package:</p> <ul style="list-style-type: none"> Handlebar with adjustable riser iBR - Intelligent Brake & Reverse Extended Range VTS Exclusive coloration 		<ul style="list-style-type: none"> Large swim platform with LinQ attachment system Ergolock two-piece seat Large front storage iBR - Intelligent Brake & Reverse Watertight phone compartment. 		<ul style="list-style-type: none"> BRP Audio - premium system (optional) iDF Intelligent Debris-Free Pump System (optional) Boarding ladder iBR - Intelligent Brake & Reverse Variable Trim System (VTS™) Slow mode/speed regulator Two color options 	
	Capacity							
RIDERS	2	2	3	2	3	3	3	
WEIGHT	160 kg	160 kg	205 kg	160 kg	205 kg	272 kg	272 kg	
FUEL	30 L			30 L		60 L	60 L	
TOTAL STORAGE	27 L	27 L		27 L	152.8 L		152.8 L	
	Rotax engine							
ROTAX® ENGINE	900 ACE™ - 60	900 ACE™ - 90		900 ACE™ - 90	900 ACE™ - 90	1630 ACE™ - 130	1630 ACE™ - 170	
INTAKE SYSTEM	Naturally aspirated			Naturally aspirated		Naturally aspirated		
DISPLACEMENT	899 cc			899 cc		1,630 cc		
REVERSE SYSTEM	Manual Reverse Kit (Accessory)	Electronic iBR®	Electronic iBR® (Optional)	Electronic iBR®		Electronic iBR®		
FUEL TYPE	95 octane			95 octane		95 octane		

	TOW SPORTS		TOURING			
	WAKE™	WAKE™ PRO	GTX™ PRO	GTX™	GTX™ LIMITED	
	Made to make the most of the wake.		Rental model.	Comfort, control and power are always in style.		
MODELS	WAKE™ 170	WAKE™ PRO 230	GTX™ PRO 130	GTX™ 170	GTX™ 230	
COLORS	NEW Neo Mint	NEW Neo Mint	White & Reef Blue	Eclipse Black & Orange Crush	NEW Premium Metallic Sage	
					NEW Liquid Titanium & Black	
	Key features					
	<ul style="list-style-type: none"> BRP Audio - premium system (optional) Large front storage Watertight phone compartment Boarding ladder iBR - Intelligent Brake & Reverse <p>WAKE Package:</p> <ul style="list-style-type: none"> LinQ retractable ski pylon Speed-based ski mode Removable wakeboard rack WAKE™ graphics 		<ul style="list-style-type: none"> NEW Full-color 7.8" wide display BRP Audio - premium system Direct-access front storage Watertight phone compartment iBR - Intelligent Brake & Reverse Boarding ladder <p>WAKE Package:</p> <ul style="list-style-type: none"> LinQ retractable ski pylon Speed-based ski mode Removable wakeboard rack WAKE™ graphics 		<ul style="list-style-type: none"> LinQ™ attachment system 18.5 US gal/70 L fuel tank capacity Boarding ladder Direct-access front storage iBR - Intelligent Brake & Reverse (optional) Watertight phone compartment Heavy-duty parts: electrical harness, handle grips, seat, wear ring, drive shaft and impeller 	<ul style="list-style-type: none"> iDF - Intelligent Debris-Free Pump System (optional 170 & 230) BRP Audio - premium system Direct-access front storage Watertight phone compartment LinQ™ attachment system iBR - Intelligent Brake & Reverse Boarding ladder Variable Trim System (VTS™) <p>Limited Package:</p> <ul style="list-style-type: none"> USB port Watercraft cover Storage bin organizer Knee pads Depth finder Exclusive coloration and more
	Capacity					
RIDERS	3	3	3	3	3	
WEIGHT	272 kg	272 kg	272 kg	272 kg	272 kg	
FUEL	60 L	70 L	70 L	70 L	70 L	
TOTAL STORAGE	152.8 L	98.9 L	98.9 L	98.9 L	98.9 L	
	Rotax engine					
ROTAX® ENGINE	1630 ACE™ - 170	1630 ACE™ - 230	1630 ACE™ - 130	1630 ACE™ - 170	1630 ACE™ - 230	
INTAKE SYSTEM	Naturally aspirated	Supercharged with external intercooler	Naturally aspirated	Naturally aspirated	Supercharged with external intercooler	
DISPLACEMENT	1,630 cc	1,630 cc	1,630 cc	1,630 cc		
REVERSE SYSTEM	Electronic iBR®	Electronic iBR®	Electronic iBR®* (optional)	Electronic iBR®		
FUEL TYPE	95 octane	95 octane	95 octane	Minimum: 95 Octane Recommended: 98 Octane		

Comparative Chart

	SPORT FISHING			PERFORMANCE		
	FISHPRO™			GTR™ 230	RXP®-X® RS 300	RXT®-X® RS 300
	Accessible, versatile and all-around fun.	The original game-changer. Find yourself a new perspective on sport fishing.	The most advanced sport fishing vehicle on the water.	Accessible power and performance.	Race-ready performance watercraft, reimagined.	The ultimate off-shore performance watercraft.
MODELS	FISHPRO™ Scout	FISHPRO™ Sport	FISHPRO™ Trophy	GTR™ 230	RXP®-X® RS 300	RXT®-X® RS 300
COLORS	 White & Gulfstream Blue	 White & Gulfstream Blue	 NEW Shark Grey & Orange Crush	 NEW Millennium Yellow	 NEW Premium Triple Black  Millenium Yellow	 NEW Premium Triple Black  Millenium Yellow
Key features						
	<ul style="list-style-type: none"> iDF - Intelligent Debris-Free Pump System Ergolock™ two-piece fishing seat 3 fishing rod holders Garmin® 6" GPS & Fish Finder - Includes free regional map token LinQ™ fishing cooler (13.5 US gal/51 L) Trolling Mode (slow mode) Front storage lid organizer 2 LinQ front supports Cup holder 	<ul style="list-style-type: none"> iDF - Intelligent Debris-Free Pump System Extended rear platform with second LinQ™ attachment system Garmin® 6" GPS & Fish Finder - Includes free regional map token LinQ fishing cooler (13.5 US gal/51 L) 5 fishing rod holders Angled gunwale footrests BRP Audio - premium system (optional) Direct access front storage with bin organizer 	<ul style="list-style-type: none"> iDF - Intelligent Debris-Free Pump System Modular swivel seat Advanced battery system LinQ™ fishing cooler (13.5 US gal/51 L) Quick-connect livewell Garmin® 7" touchscreen GPS & Fish Finder - Includes free regional map token Anchoring system NEW Tech Package: BRP Audio - premium system & full-color 7.8" wide display (optional) 	<ul style="list-style-type: none"> BRP Audio - premium system (optional) Large front storage Watertight phone compartment LinQ™ attachment system VTS™ - Variable Trim System 	<ul style="list-style-type: none"> Ergolock™ R racing seat T3-R hull NEW Tech Package: BRP Audio - premium system & full-color 7.8" wide display (Optional) Launch control Low-rise racing handlebar Double-angled footwell wedges X-sponsons 	<ul style="list-style-type: none"> Ergolock two-piece racing seat ST3 hull NEW Tech Package: BRP Audio - premium system & full-color 7.8" wide display Launch control Tilt steering Full-length angled footwell wedges X-sponsons
Capacity						
RIDERS	3	3	3	3	2	3
WEIGHT	272 kg	272 kg	272 kg	272 kg	182 kg	272 kg
FUEL	60 L	70 L	70 L	60 L	70 L	70 L
TOTAL STORAGE	203.8 L	149.9 L	149.9 L	160.8 L	153.7 L	98.9 L
Rotax engine						
ROTAX® ENGINE	1630 ACE™ - 130	1630 ACE™ - 170	1630 ACE™ - 170	1630 ACE™ - 230	1630 ACE™ - 300	1630 ACE™ - 130
INTAKE SYSTEM	Naturally aspirated	Naturally aspirated	Naturally aspirated	Supercharged with external intercooler	Supercharged with external intercooler	Supercharged with external intercooler
DISPLACEMENT	1,630 cc	1,630 cc	1,630 cc	1,630 cc	1,630 cc	1,630 cc
REVERSE SYSTEM	Electronic iBR®	Electronic iBR®	Electronic iBR®	Electronic iBR®	Electronic iBR®	Electronic iBR®
FUEL TYPE	95 octane	95 octane	95 octane	95 octane	98 octane	98 octane

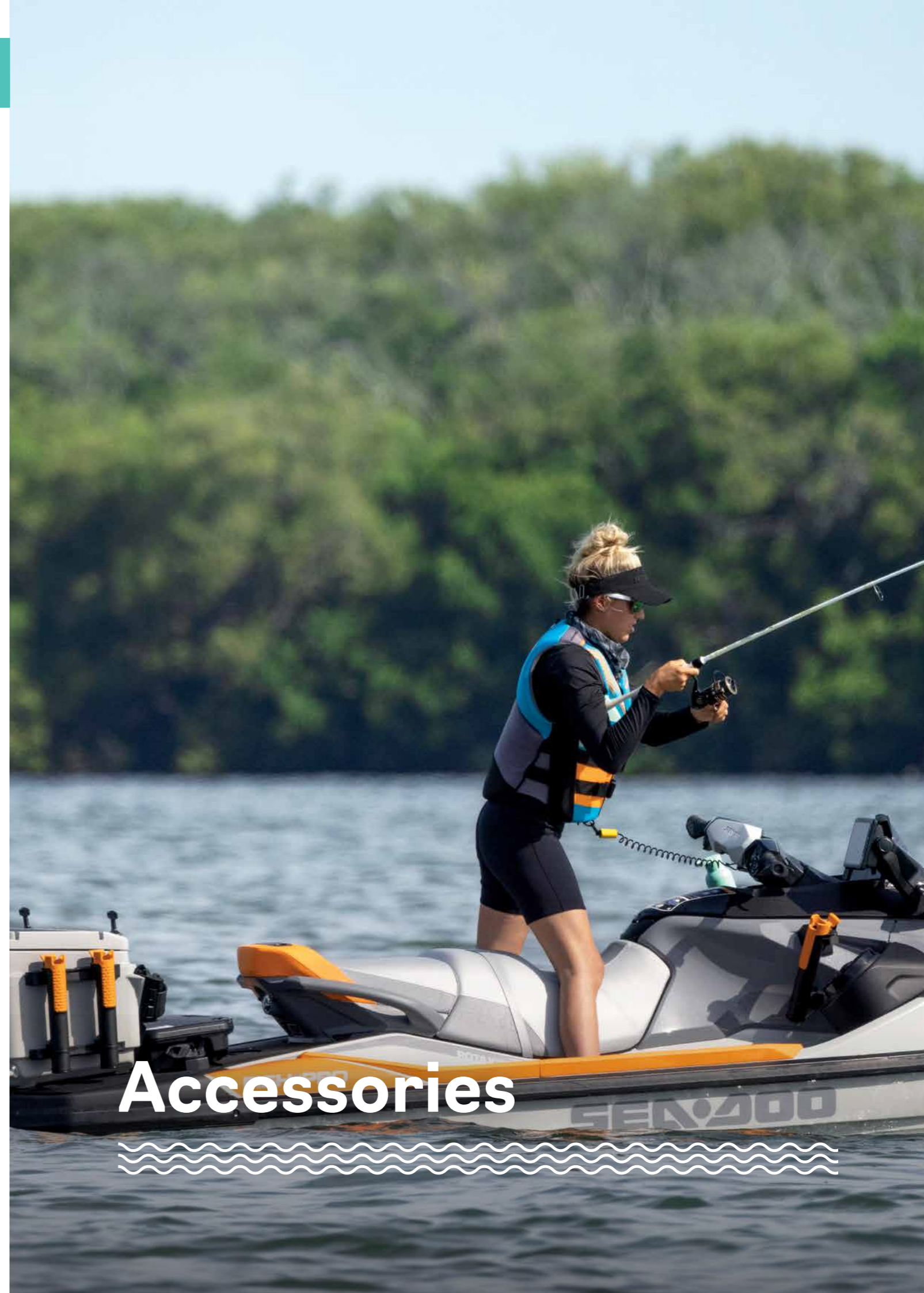

Accessories

Accessories

- 41 Essential Bundles
- 42 Lifestyle Bundles
- 44 LinQ Accessories
- 48 Bags and Storage
- 49 Watersport Accessories
- 50 Steps and Ladder
- 50 Controls and Grips
- 53 Tech Accessories
- 54 Electronics and Electricals
- 58 Body accessories
- 59 Docking
- 61 Riding Essentials
- 62 Covers
- 64 Trailers
- 67 Trailer Accessories
- 68 Graphic Kits

Sea-Doo Accessories limited warranty*

2-Year on BRP Accessories

*Purchased at an authorized BRP dealership/distributor or on a BRP-authorized online store. Unless otherwise stipulated or required by law. Other exclusions may apply. See complete limited warranty or contact your authorized Sea-Doo dealer. This limited warranty does not apply to factor-installed accessories.

Essential Bundles



STARTER

SKU	NAME	PAGE
295100330	Safety Equipment Kit	p. 61
295100833	Fire Extinguisher	p. 61
295100570	Registration Kit Black	p. 61
295101014	Cover	p. 62
285938	PFD	p. 86
286808	Neoprene Short	p. 89

ADVANCED

SKU	NAME	PAGE
295100750	Folding Anchor	p. 60
295100851	Dock Tie	p. 60
295100418	Snap-In Fenders	p. 59
295100944	Snap-In Fenders Installation Kit	p. 59
278003401	RF programmable D.E.S.S.™ Key	p. 55
295100901	All-Climate Storage cover	p. 62
779310	XPS Wash & Wax	p. 74
779320	XPS Spray Wax with Polymer	p. 74
454493	Long Sleeve Rashguard Beach	p. 86
454478	Adventure Wide Brim Hat	p. 98

PEAK

SKU	NAME	PAGE
269502121	Dry Bag - 10 L	p. 48
295100814	Removable Storage Bin Organizer	p. 48
295100862	Lid Organizer	p. 48
295100965	Sea-Doo Cooler Bag	p. 48

Note that the price does not include installation requirements and that parts numbers may vary depending on vehicle model.

Lifestyle Bundles



WATERSPORTS

SKU	NAME	PAGE
295100909	LinQ Retractable Ski Pylon	p. 49
295100838	Wakeboard Rack	p. 49
295100662	Shock Tube	p. 50
715007112	LinQ Modular Cargo box 20 L	p. 44



PERFORMANCE

SKU	NAME	PAGE
295100950	LinQ Stackable Fuel Caddy	p. 44
295100746	Handlebar with Adjustable Riser	p. 50
295100847	Pro-Series Sponson Kit	p. 69
295100845	Top-Loader Intake Grate	p. 69
295100846	Pump Seal Kit	p. 69
295100875	Floorboard wedges	p. 58
295100810	Ergolock Knee Pads	p. 58

Note that the price does not include installation requirements and that parts numbers may vary depending on vehicle model.



FISHING







SKU	NAME	PAGE
269801151	LinQ 13.5 US Gal (51 L) Cooler	p. 46
295101033	LinQ 13.5 US Gal (51 L) Cooler Extension	p. 46
295101057	Garmin ¹ ECHOMAP™ UHD 72sv GPS	p. 54
295100972	Garmin ¹ GT15M-IH Transducer	p. 54
295100991	Secondary Battery Harness Kit	p. 55
295100793	Angles Gunwale Footrests	p. 58
295100948	LinQ Front Support (LH)	p. 46
295100949	LinQ Front Support (RH)	p. 46
295100795	LinQ Rod Holder	p. 46
295100935	LinQ Cup Holder	p. 46
715005494	LinQ Modular Cargo Box 10 L	p. 44
219401110	Thermal Insert for LinQ Modular Cargo Box (10 L)	p. 45

ADVENTURE

SKU	NAME	PAGE
295101015	LinQ Multi Cargo Rack	p. 45
295101034	LinQ installation base kit For LinQ Multi Cargo Rack	p. 47
295100950	LinQ Stackable Fuel Caddy	p. 44
295101009	LinQ installation base kit For LinQ Stackable Fuel Caddy	p. 47
295100812	Heated Grips	p. 52
860202478	LinQ Lock - Pack of 2	p. 47
715005494	LinQ Modular Cargo box 10 L	p. 44
715007112	LinQ Modular Cargo box 20 L	p. 44
219401110	Thermal Insert for LinQ Modular Cargo Box (10 L)	p. 45
715008110	LinQ Watertight Bag	p. 44
295100948	LinQ Front Support (LH)	p. 46
295100949	LinQ Front Support (RH)	p. 46
295100935	LinQ Cup Holder	p. 46
295100698	LinQ 4.2 US Gal (16 L) Cooler	p. 45

Note that the price does not include installation requirements and that parts numbers may vary depending on vehicle model.

LinQ Accessories

LinQ Stackable Fuel Caddy - 4 Gallons	Models with LinQ Base Kit	295100950
	<ul style="list-style-type: none"> Quickly and easy, secure installation with the LinQ accessory system. No-spill spout designed for easy pouring. 3.8 US Gal (14.5 L) capacity. Allows for added storage by stacking LinQ Watertight Bag (715008110). 	<ul style="list-style-type: none"> Marinized for saltwater use. <p><i>Notes: LinQ Base Installation Kit is required to install LinQ accessories when not standard on the watercraft. Fuel caddies cannot be stacked. Stacking LinQ Watertight Bag requires LinQ Base Installation kit (295101009).</i></p>
LinQ Fuel Caddy Replacement Rubber Cap	295100791	
		
LinQ Fuel Caddy Replacement Cap and Nozzle <i>(Not illustrated)</i>	860202529	
LinQ Watertight Bag	Models with LinQ Base Kit	715008110
	<ul style="list-style-type: none"> Fully waterproof roll-top design secures gear tightly. 10.6 US Gal (40 L) of adjustable capacity. Heavy-duty rigid plastic base. Foam-lined bottom for additional protection. 	<ul style="list-style-type: none"> Integrated handle for easy transportation on/off the vehicle. Equipped with Marinized LinQ Hardware Kit. <p><i>Note: LinQ Base Installation Kit is required to install LinQ accessories when not standard on the watercraft.</i></p>
LinQ Box	Models with LinQ Base Kit	715008111
	<ul style="list-style-type: none"> High-precision injected HDPE construction provides rigidity and durability. 5 US Gal (19 L) maximum capacity. Weather-resistant, sealed and lockable cover. 	<ul style="list-style-type: none"> Equipped with Marinized LinQ Hardware Kit. <p><i>Note: LinQ Base Installation Kit is required to install LinQ accessories when not standard on the watercraft.</i></p>
NEW LinQ Modular Cargo Box 10 L	Models with LinQ Base Kit	715005494
	<ul style="list-style-type: none"> 10 L (2.6 US Gal) of hard-sided modular storage capacity. Heavy duty construction with weather resistant sealed lid. 	<ul style="list-style-type: none"> Stackable with single LinQ bag or additional modular boxes for the ideal storage solution. <p><i>Note: LinQ Base Installation Kit is required to install LinQ accessories when not standard on the watercraft.</i></p>
NEW LinQ Modular Cargo Box 20 L	Models with LinQ Base Kit	715007112
	<ul style="list-style-type: none"> 20 L (5.2 US Gal) of hard-sided modular storage capacity. Heavy duty construction with weather resistant sealed lid. 	<ul style="list-style-type: none"> Stackable with single LinQ bag or additional modular boxes for the ideal storage solution. <p><i>Note: LinQ Base Installation Kit is required to install LinQ accessories when not standard on the watercraft.</i></p>
NEW LinQ Modular Cargo Box 30 L	Models with LinQ Base Kit	715006830
	<ul style="list-style-type: none"> 30 L (7.8 US Gal) of hard-sided modular storage capacity. Heavy duty construction with weather resistant sealed lid. 	<ul style="list-style-type: none"> Stackable with single LinQ bag or additional modular boxes for the ideal storage solution. <p><i>Note: LinQ Base Installation Kit is required to install LinQ accessories when not standard on the watercraft.</i></p>

NEW Thermal Insert for LinQ Modular Cargo Box (10 L)		219401110
	<ul style="list-style-type: none"> Insulated liner. Fits very well in the LinQ Modular Box (10 L). Can contain five 473 ml cans or six 355 ml cans. 	
NEW LinQ Multi Cargo Rack	GTX, RXT-X, WAKE PRO (2018 and up) / GTI, GTR, WAKE (2020 and up) / RXP-X (2021 and up) / All FISHPRO models (2019 and up)	295101015
	<ul style="list-style-type: none"> Adds up to three times the available LinQ accessory to your watercraft. Enables multiple LinQ accessory configurations - including stackable accessories for even more carrying capacity. Provides a larger lounging area or casting platform and easier reboarding. 	<ul style="list-style-type: none"> Uses equipped LinQ attachment system for quick, easy installation. Two LinQ Base Installation kits included. Additional base installation kits sold separately (295101034).
NEW Rear Deck Extension with LinQ	GTX, RXT, RXT-X & WAKE PRO (2018 and up)	295101059
	<ul style="list-style-type: none"> Adds 11.5 inches of platform space to the rear of the watercraft. Includes retractable LinQ attachment point to allow for easy LinQ accessory installation and stow out of the way when not in use. 	<ul style="list-style-type: none"> Easy access to water for swimming and other watersports. Extra space for onboard lounging, fishing and more. Also compatible with the Ladder.
LinQ 4.2 US Gal (16 L) Cooler	Models with LinQ Base Kit	295100698
	<ul style="list-style-type: none"> Secure, easily installed LinQ-mounted cooler. Premium-quality foam insulation holds ice up to five days. Rotomolded construction for exceptional rigidity and durability. Sealed lid for airtight, weather-tight closure. 	<ul style="list-style-type: none"> Heavy duty T-Handle latches resistant to marine environments. Marinized hardware suited for saltwater applications. <p><i>Notes: Cannot be mounted on the LinQ Stackable Fuel Caddy. LinQ Base Installation Kit is required to install LinQ accessories when not standard on the watercraft.</i></p>
LinQ 13.5 US Gal (51 L) Cooler (Single Latch)	RXT, RXT-X, GTX, GTX Ltd, WAKE PRO (2018 and up) / RXP-X (2021 and up) / GTI, GTI SE, GTR, WAKE (2020 and up)	269800943
	<ul style="list-style-type: none"> 13.5 US Gal (51 L) of insulated, water-resistant capacity. Exceptionally rigid and highly durable with premium-quality foam insulation for optimal ice retention. Sealed cover keeps the heat and water out. Heavy duty external storage pocket adds extra room for non-cooled essentials like utensils, tackle and more. Top features recessed workspace with anti-slip surface ideal for baiting hooks, and includes fish ruler molded into the top for quickly measuring your catch. 	<ul style="list-style-type: none"> Two drain plugs for easily emptying water. Pre-molded slots for easy installation of rod holders or cup holders on each side. Angled trolling slots for the perfect multi-rod trolling setup where regulations allow. LinQ 13.5 US Gal (51 L) Cooler Extension (29510888) can be added on top for more storage. <p><i>Notes: LinQ Locking Anchor Base Kit (295100858) is required for installation on 2018 models and on some 2019 models. If your watercraft is not equipped with a ladder, adding one for easy reboarding is recommended. Cooler does not fit with LinQ Ski Pylon when in forward position.</i></p>
LinQ 13.5 US Gal (51 L) Cooler Extension (Single Latch)	LinQ 13.5 US Gal (51 L) Cooler (Single Latch)	295100888
	<ul style="list-style-type: none"> Add 5.3 US Gal (20 L) of extra storage to your existing 13.5 US Gal (51 L) cooler. Fully insulated and easy to install. Ideal, e.g., for separating your lunch from your catch or a separate tackle box. 	<ul style="list-style-type: none"> Requires LinQ 13.5 US gal (51 L) Cooler (Single Latch) (269800943) for installation.

LinQ 13.5 US Gal (51 L) Cooler (Double Latch)	RXT, RXT-X, GTX, GTX Ltd, WAKE PRO (2018 and up) / RXP-X (2021 and up) / GTI, GTI SE, GTR, WAKE (2020 and up)	269801151
 <ul style="list-style-type: none"> 13.5 US Gal (51 L) of insulated, water-resistant capacity. Exceptionally rigid and highly durable with premium-quality foam insulation for optimal ice retention. Sealed cover keeps the heat and water out. Heavy duty external storage pocket adds extra room for non-cooled essentials like utensils, tackle and more. Top features recessed workspace with anti-slip surface ideal for baiting hooks, and includes fish ruler molded into the top for quickly measuring your catch. Two drain plugs for easily emptying water. T-Handle heavy-duty latches are durable and resistant to marine environments including salt water. 	<ul style="list-style-type: none"> Pre-molded slots for easy installation of rod holders or cup holders on each side. Angled trolling slots for the perfect multi-rod trolling setup where regulations allow. LinQ 13.5 US GAL (51 L) Cooler Extension (295101033) can be added on top for more storage. <p><i>Note: LinQ Locking Anchor Base Kit (295100858) is required for installation on 2018 models and on some 2019 models. If your watercraft is not equipped with a ladder, adding one for easy reboarding is recommended. Cooler does not fit with LinQ Ski Pylon when in forward position.</i></p>	

LinQ 13.5 US Gal (51 L) Cooler Extension (Double Latch)	LinQ 13.5 US Gal (51 L) Cooler (Double Latch) (269801151)	295101033
 <ul style="list-style-type: none"> Add 5.3 US Gal (20 L) of extra storage to your existing 13.5 US Gal (51 L) cooler. Fully insulated and easy to install. Ideal, e.g., for separating your lunch from your catch or a separate tackle box. 	<ul style="list-style-type: none"> Requires LinQ 13.5 US gal (51 L) Cooler (Double Latch) (269801151) for installation. 	

LinQ Rod Holder	Fits LinQ Front Supports and LinQ 13.5 US Gal (51 L) Coolers	295100795
 <ul style="list-style-type: none"> Perfect to safely transport your fishing rods to your favorite fishing spots or for trolling. Features quick attachment system with release lever for easy installation onto / removal from any of the 30 different positions on the LinQ 13.5 Gal (51 L) Cooler or in front of some vehicle using the LinQ Front Supports. 	<ul style="list-style-type: none"> Firmly holds fishing rod using a molded rubber cap specifically designed to quickly secure or remove the fishing rod using the reel arm. 	

LinQ Front Support	RXT, RXT-X, GTX, WAKE PRO (2018 and up), FISHPRO (2019-2021), FISHPRO SPORT, FISHPRO TROPHY	295100948 Left side 295100949 Right side
 <ul style="list-style-type: none"> Enables the installation of front-mounted LinQ Rod Holder (295100795) or LinQ Cup Holder (295100935) (sold separately). Allows for easy access to beverages or rod during trolling without impeding the driver. 		

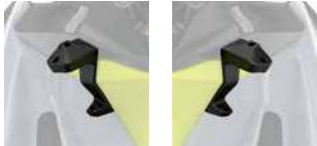
NEW LinQ Front Support	GTI, GTR, WAKE (2020 and up), FISHPRO SCOUT	295101039 Left side 295101040 Right side
 <ul style="list-style-type: none"> Enables the installation of front-mounted LinQ Rod Holder (295100795) or LinQ Cup Holder (295100935) (sold separately). Allows for easy access to beverages or rod during trolling without impeding the driver. 		

LinQ Cup Holder		295100935
 <ul style="list-style-type: none"> Cup holder fits most beverage containers thanks to flexible fins that adjust to size of beverage. Can be installed on the 13.5 US Gal (51L) cooler or on LinQ Front Supports. Tool-less installation. 		

NEW LinQ Lock	Retrofits most LinQ accessories	860201968 Pack of 1 with 2 keys 860202478 Pack of 2 with 4 keys
 <ul style="list-style-type: none"> Simple way to securely lock most LinQ accessories to your watercraft. Lock cover protects lock from the elements. Corrosion resistant. 		<ul style="list-style-type: none"> Not compatible with LinQ 4.2 US gal (16 L) Cooler, LinQ Retractable Ski Pylon and LinQ Box.

LinQ Base Installation Kit	GTI, GTS, GTR (2011-2019) / GTR-X (2017-2019) / RXP (2012-2020) / GTX (2016-2017) / RXT-X (2016-2017)	295100803 295100842
 <p>(295100803 illustrated)</p> <ul style="list-style-type: none"> Allows you to install LinQ mounted accessories on your Sea-Doo watercraft to extend cargo options and journey opportunities. Allow the installation of LinQ accessories to the back of your watercraft. 		<ul style="list-style-type: none"> Not compatible with the LinQ 13.5 US Gal (51 L) Cooler. Includes 2 LinQ bases and hardware. If your watercraft is not equipped with a ladder, adding one for easy reboarding is recommended. <p><i>Note: Not compatible with rear Speed Tie.</i></p>

LinQ Base installation Kit	SPARK 2up SPARK 3up*	295100883 295100802
 <p>(295100883 illustrated)</p> <ul style="list-style-type: none"> Allows you to install LinQ mounted accessories on your Sea-Doo watercraft to extend cargo options and journey opportunities. Allow the installation of LinQ accessories to the back of your watercraft. 		<ul style="list-style-type: none"> Not compatible with the LinQ 13.5 US Gal (51 L) Cooler. Includes 2 LinQ bases and hardware If your watercraft is not equipped with a ladder, adding one for easy reboarding is recommended. <p><i>*Not compatible with the Tow Pro (295100605).</i></p>

LinQ Base Installation Kit	Fits LinQ Stackable Fuel Caddy	295101009
 <ul style="list-style-type: none"> LinQ Base kit allows select Sea-Doo LinQ accessories to be stacked on top of the LinQ Stackable Fuel Caddy (295100950). Includes 2 LinQ bases and maritized hardware for quick install. 		



LinQ Base Installation Kit	Fits LinQ Multi Cargo Rack	295101034
 <ul style="list-style-type: none"> LinQ Base kit allows use of up to three Sea-Doo LinQ accessories simultaneously on the LinQ Multi Cargo Rack. Includes 2 LinQ bases and maritized hardware for quick install. 		

LinQ Update Locking Anchor Base Kit (Not illustrated)	RXT, RXT-X, GTX, GTX Ltd and WAKE PRO (2018 and some 2019)	295100858
	<ul style="list-style-type: none"> LinQ bases with locking system for staying in the "up" position while installing LinQ accessories. Required on 2018 models and some 2019 models, to install the LinQ 13.5 Gal (51 L) Cooler (269800943). 	<ul style="list-style-type: none"> Replaces standard LinQ bases. Standard on all vehicle with LinQ (from factory) 2020 and up.





Maritized LinQ Hardware Kit	295100751
 <ul style="list-style-type: none"> Essential upgrade for LinQ Bags when used on watercraft in saltwater. Includes stainless steel LinQ hardware to render your LinQ fully corrosion proof. 	<ul style="list-style-type: none"> Quick and easy installation. Not required for installation of the LinQ Coolers, LinQ Watertight Bag and LinQ Box.

Bags and Storage

NEW Sea-Doo 14 L Cooler Bag	GTI, GTI SE, GTR, WAKE 170 (2020 and up) / GTX, GTX LTD, RXT-X, WAKE PRO (2018 and up) / All FISHPRO models (2019 and up)	295100965
	<ul style="list-style-type: none"> 14 L (3.7 US Gal) of thermal insulated soft-sided storage. Waterproof sealed construction. Magnetic top opening for quick access and sure seal when closed. Can hold ice for 2 days. 	<ul style="list-style-type: none"> Robust outer material for durability with a modern look. Carry handles and removable straps for easy transport to and from the water. Outside identification pocket. Dimensions: 13 3/4" L x 12 1/4" W x 9" H (35 cm L x 31 cm W x 22.5 cm H).
Removable Storage Bin Organizer	RXT, RXT-X, GTX, WAKE PRO (2018 and up) / FISHPRO (2019-2021), FISHPRO SPORT, FISHPRO TROPHY GTI, GTI SE, GTR and WAKE 170 (2020 and up) / RXP-X (2021 and up) / FISHPRO SCOUT	295100732 295100814
	<ul style="list-style-type: none"> Breathable front bin organizer made from high-quality premium-coated synthetic mesh. Perfect for storing wet clothes away from the rest of your gear or to transport gear to/from the watercraft. Carrying handle and easy storage on or off the watercraft. 	<ul style="list-style-type: none"> Quick-attach fasteners to secure the bag in place inside the storage bin. Designed to be installed with the Storage Bin Organizer (295100835) for a complete set-up (295100732 only).
Storage Bin Organizer	RXT, RXT-X, GTX, WAKE PRO (2018 and up) / FISHPRO (2019-2021), FISHPRO SPORT, FISHPRO TROPHY	295100835
	<ul style="list-style-type: none"> Leave-in breathable premium-coated synthetic mesh organizer. Perfect for safely storing and organizing smaller valuables. 	<ul style="list-style-type: none"> Designed to be installed in conjunction with the Removable Storage Bin Organizer for a complete set-up (295100732). Standard on GTX Ltd models (2018 and up).
Lid Organizer	GTI, GTI SE, GTR and WAKE 170 (2020 and up) / RXP-X (2021 and up) / FISHPRO SCOUT	295100862
	<ul style="list-style-type: none"> Practically positioned in an easily accessible location in front compartment. Keep your small items dry in splash-proof inner pocket. 	<ul style="list-style-type: none"> External mesh pocket allows you to store more items while keeping them in view. 1.6 US Gal (6 L) volume.
Dry Bag - 10 L	269502121	
	<ul style="list-style-type: none"> Watertight bag. Puncture-resistant PVC coated polyester fiber material. Reinforced bottom. 	
Dry Bag - 25 L	269001936	
	<ul style="list-style-type: none"> Watertight bag. Puncture-resistant PVC coated polyester fiber material. Reinforced bottom. Includes a shoulder strap. 420-denier resistant polyester with TPU coating. 	
Front Deflector Lid Kit	SPARK	295100865
	<ul style="list-style-type: none"> Made of polypropylene, this removable deflector directs water away from the driver's feet and legs for a drier ride. BRP Audio-Portable System compatible. 	

Front Storage Bin Kit	SPARK	295100864
	<ul style="list-style-type: none"> Soft-sided design matches the contours of the SPARK to maximize storage. 7.4 US Gal (28 L) capacity. Polyurethane construction protects items from rough waves. Drain holes at bottom. BRP Audio-Portable System compatible. Front Deflector Lid Kit is included. 	
Front Storage Tray	RXP-X (2012-2020) / GTI and GTS (2011-2019) / GTR (2012-2019) / WAKE 155 (2011-2019)	295100583*
	<ul style="list-style-type: none"> Optimizes storage space. 3.2 US Gal (12 L) capacity. 	

Watersport Accessories

Tow Pro	SPARK 3up	295100605
	<ul style="list-style-type: none"> Three accessories in one – a tow pylon, spotter handle and equipment rack. Add more fun to pulling wakeboarders, wakeskaters and tubers thanks to higher tow point. Gives the spotter more confidence with ergonomic grab handles. Carry your board out to clear water. Includes a strap for conveniently stowing your tow rope. Not compatible with SPARK 3 up LinQ Base Installation Kit (296100802). <p><i>Note: Never use the Ski Pylon to tow an inflatable or similar toy. Always use the rear cleat.</i></p>	
LinQ Retractable Ski Pylon	RXT, RXT-X, GTX, GTX Ltd (2018 and up) / GTI, GTI SE, GTR (2020 and up) / All FISHPRO models (2019 and up)	295100909
	<ul style="list-style-type: none"> High-rise pylon keeps rope out of water for better watersport fun. Features built-in spotter grab handles and retracts out of the way when not in use. <p><i>Note: Never use the Ski Pylon to tow an inflatable or similar toy. Always use the rear cleat.</i></p>	
Strap Replacement Kit	295100740	
		
Wakeboard Rack	RXT, RXT-X, GTX, GTX Ltd, WAKE PRO (2018 and up) / GTI, GTI SE, GTR, WAKE (2020 and up) / FISHPRO SCOUT	295100838
	<ul style="list-style-type: none"> Easy, safe onboard storage for your wakeboard. Convenient quick-release button for fast access. EVA foam cushion protects board edge while underway. Bungee cord with rubber pads holds board in place while preventing wear on the cord. Accommodates most sizes and styles of wakeboards and wakeskates. Sold individually, each rack holds one wakeboard. Standard on WAKE and WAKE PRO models. Parts numbers 291003104- 291002864 required for installation on GTI and GTS (2011-2019). Parts numbers 291003582-291002864 required for installation on RXT and GTX (2010-2017). Not compatible with angled gunwale footrests (stock on FishPro Sport and FishPro Trophy) 	

*While supplies last.

Shock Tube		295100662
	<ul style="list-style-type: none"> Protects passengers from ski rope kick-back and keeps it away from impellers. Durable nylon covered closed-cell foam. 	

Ski Tow Eye	GTX, GTS, GTI, RXT and GTR	291002351
	<ul style="list-style-type: none"> Replaces existing U-ring for easy towing of skiers and tubes. 	

Steps and Ladder

Boarding Step	SPARK	295100642
	<ul style="list-style-type: none"> Convenient step with knee-friendly surface. Installs easily on the right side of a SPARK and can hold up to 250 lb (113 kg). Easily mounts on the transom and can be installed by any authorized Sea-Doo dealer in minutes. 	

Boarding Ladder	RXT, RXT-X, GTX and WAKE PRO (2018 and up) / GTI, GTI SE, GTR and WAKE 170 (2020 and up) / RXP-X (2021 and up) / All FISHPRO models (2019 and up)	295100869
	GTI, GTS, GTR (2006-2019) / RXP (2006 - 2020) / RXT-X and GTX (2006-2017)	295100742

	<ul style="list-style-type: none"> Retractable boarding step designed for your watercraft. Makes boarding from the water much easier. Spring-loaded platform that stays in the "up" position. Direct bolt-on installation, thanks to integrated mounting points on the watercraft. 	
--	--	--

Controls and Grips

Handlebar with Adjustable Riser	SPARK	295100746
	<ul style="list-style-type: none"> The one-of-a-kind handlebar with adjustable riser gives you more leverage to easily maneuver the SPARK and customize your experience to your personal riding style. Quickly adjust steering to a variety of heights - use the lower position for cruising/sitdown riding, or extend to maximum height in seconds for stand-up riding. Adjustable length of 1.6" to 4" (42.5 mm to 103.5 mm). Just flip the lever to make the adjustment, no tool required. 	<p>Part numbers you will also need for installation:</p> <p>SPARK without iBR*</p> <ul style="list-style-type: none"> 2016 and prior: 278003491, 295100702 2017 and up: 278003491 <p>SPARK with iBR</p> <ul style="list-style-type: none"> 2016 and prior: 278003490, 295100702 2017: 278003490 2018 and up: 278003823 <p><i>*Intelligent Brake and Reverse (iBR).</i></p>

Adjustable Riser	RXP-X (2021 and up)	295100922
	<ul style="list-style-type: none"> Replaces stock fixed extrusion to allow vertical adjustment length of +$\frac{1}{8}$ to 3 $\frac{3}{8}$ (+16mm to 92 mm) from stock. Ergonomically better in stand-up riding position. Includes all hardware required for installation. 	

Adjustable Riser Retrofit Kit	SPARK (2016 and prior)	295100702
	<ul style="list-style-type: none"> Replaces stock central console to allow for installation of Handlebar with Adjustable Riser. Handlegrips with Palm Rest included. Reinforced design, includes all hardware required for installation. 	

Step Wedges	SPARK	295100705
	<ul style="list-style-type: none"> Provide more stability and confidence in different tail stand riding positions. 	<ul style="list-style-type: none"> Rear footrest with a 45-degree slope to enable you to stand upright on your watercraft when performing tail stands and ultimately expand your range of possibilities by making it easier to pull off even more tricks.

Extended Range Variable Trim System (VTS) <i>(Not illustrated)</i>	SPARK with iBR (2017 and up - full extended range), (2016 and prior - stock range)	295100704
	<ul style="list-style-type: none"> This Sea-Doo exclusive accessory lets you exaggerate how high you can raise the nose or how deep you can bury it in the water. The extended range VTS doubles the range of adjustment compared to our current standard VTS. 	<ul style="list-style-type: none"> Adjustments are instantaneous thanks to the quick activation switch mounted on the handlebar to allow fine tuning of the watercraft trim angle while riding. Simple plug-in connection, and includes switch, cap and hardware necessary for installation. Standard on SPARK TRIXX.





Wiring Harness	SPARK with iBR (2017 and prior)	278003490
	SPARK with iBR (2018 and up)	278003823
	SPARK without iBR	278003491
	<ul style="list-style-type: none"> Required in order to install the Handlebar with Adjustable Riser (295100746) and/or RF D.E.S.S Key (295100945). 	<ul style="list-style-type: none"> Works for either accessory or when using both at the same time, so no need to buy a second harness.

Handlebar	GTR-X (2016-2019) / RXP-X (2016 and up) / SPARK with Adjustable Riser	<ul style="list-style-type: none"> 277002069 Neon Yellow 277002173 Dragon Red 277002172 White 277002123 Jungle Green 	<ul style="list-style-type: none"> 277002139 Millenium Yellow 277002161 Manta Green
		<ul style="list-style-type: none"> $\frac{7}{8}$" (22 mm) colored stainless steel handlebar. 	

Wind Deflectors for Handlebar	GTX, RXT, RXT-X, and WAKE PRO (2010 and up) / GTI, GTS and WAKE (2011 and up) / GTR and RXP-X (2012 and up) / SPARK (2014 and up)	295100762
	<ul style="list-style-type: none"> Design delivers better protection and great style. Protection from cold wind and water splashes. Sold in pairs. 	

<p>Heated Grips</p> 	<p>RXT, RXT-X, GTX, GTX Ltd, WAKE PRO (2018 and up) / RXP-X (2021 and up) / GTI, GTI SE, GTR, WAKE (2020 and up) / All FISHPRO models (2019 and up) Heated grip harness required to install on other vehicles</p>	<p>295100812</p> <ul style="list-style-type: none"> • Heated grips with integrated button on the left grip. • 5 levels of heat. • Slip on to replace existing grips. • Integrate Sea-Doo's renowned palm rest design. <ul style="list-style-type: none"> • Use with Wind Deflectors for handlebar (295100762) for maximum performance. • Harness (278003684) is needed if installed with audio system or with GARMIN ECHOMAP™ UHD 72sv or 62cv GPS.
<p>Heated Grips Harness</p> 	<p>Needed for installation on some vehicles: GTX, RXT, WAKE PRO (2011-2017) / GTI, GTS, GTR, WAKE (2011-2019) / GTR-X (2018-2019) / RXP-X (2018-2020) / SPARK</p>	<p>295100906</p>
<p>Handgrips Kit</p> 	<p>Fits all watercraft (2000 and up) except SPARK (2015 and prior)</p> <ul style="list-style-type: none"> • Better control and comfort using dual density rubber design. 	<ul style="list-style-type: none"> ● 295500976 Blue/Black · Pairs ● 295500979 Red/Black · Pairs ● 295500981 Yellow/Black · Pairs ● 277001336 Slate Grey/Black · Sold individually
<p>Handgrip with Palm Rest</p> 	<p>GXT, RXT, RXT-X and WAKE PRO (2010 and up) / GTI, GTS and WAKE (2011 and up) / GTR (2012 and up) / RXP-X (2012 and up) / SPARK (2014 and up) / All FISHPRO models</p> <ul style="list-style-type: none"> • Designed and profiled to deliver a much firmer grip with less effort, allowing you greater control and comfort on longer rides, minus the hand fatigue. • Sold individually. 	<ul style="list-style-type: none"> ● 277001946 Black · Right ● 277002014 Red · Right ● 277001958 Black · Left ● 277002015 Red · Left
<p>NEW Performance Handgrip</p> 	<p>Fits all watercraft (2000 and up) except SPARK (2015 and prior)</p> <ul style="list-style-type: none"> • Race-inspired rounded design for superior comfort. • Designed for more surface contact with the handlebars for awesome confidence when riding aggressively. • Sold individually. 	<p>277001624</p>

Tech Accessories

<p>BRP Audio-Portable System</p> 	<p>SPARK</p> <ul style="list-style-type: none"> • 50 watt audio system with Bluetooth¹ connectivity. • Fully submersible and removable, can be used on and off the watercraft. • Front mounted and positioned toward driver for maximum sound clarity. • Control pad on the speaker for volume and song adjustment. • Powered with a rechargeable lithium battery that offers 24 hours* of autonomy. • Support base with quick-attach system is required (295101051). 	<p>295101042 (US) 295101043 (EU)</p> <ul style="list-style-type: none"> • Needed if installed in front of the Spark: Front Deflector Replacement Lid (295100870) is required when installing the sound system on 2018 and prior models with iBR and Convenience Package or when the Front Storage Bin Kit (295100864) or the Front Deflector Lid Kit (295100865) is installed. • Adjustable Riser Retrofit Kit (295100702) is required to install on SPARK (2016 and prior).
<p>Front Deflector Replacement Lid</p> 	<p>SPARK</p> <ul style="list-style-type: none"> • Required when installing the BRP Audio-Portable System (295101042) on SPARK with iBR and Convenience Package (2018 and prior). • Also needed when the Front Storage Bin Kit (295100864) or the Front Deflector Lid Kit (295100865) is installed on the watercraft. 	<p>295100870</p> <ul style="list-style-type: none"> • Included on 2019 and up models equipped with the same feature. • To install the audio system in front of the Spark only.
<p>BRP Audio-Portable System Support Base</p> 	<p>SPARK</p> <ul style="list-style-type: none"> • Required to install the BRP Audio-Portable System (295101042). 	<p>295101051</p>
<p>BRP Audio-Premium System</p> 	<p>RXT, RXT-X, GTX, WAKE PRO (2018 and up) / FISHPRO (2019-2021), FISHPRO SPORT, FISHPRO TROPHY GTI, GTI SE, GTR and WAKE 170 (2020 and up) / RXP-X (2021 and up) / FISHPRO SCOUT</p> <ul style="list-style-type: none"> • Fully integrated Audio System with Bluetooth connectivity. • Fully submersible. • Two powerful 50 watt speakers for music clarity, even while riding. 	<p>295100711 295100839</p> <ul style="list-style-type: none"> • Remote control pad on left speaker to quickly and easily change songs and volume. • Music will play even after engine is turned off. • Need harness (278003684) if installed with the Garmin ECHOMAP™ UHD 72sv or 62cv GPS or heated grips.
<p>USB Port</p> 	<p>RXT, RXT-X, GTX, WAKE PRO (2018 and up) / RXP-X (2021 and up) / GTI, GTI SE, GTR, WAKE (2020 and up) / All FISHPRO models (2019 and up)</p> <ul style="list-style-type: none"> • Allows to charge your devices like phone and action camera. • USB charger equipped with a smart module that detects the amperage your phone needs so you always enjoy consistent charge time and never have to worry about frying your device. 	<p>295100710</p>

Electronics and Electricals



NEW Garmin [†] ECHOMAP™ UHD 72sv GPS	RXT, RXT-X, GTX, WAKE PRO (2019 and up) / GTI, GTI SE, GTR and WAKE 170 (2020 and up) / RXP-X (2021 and up)	295101057
--	---	------------------



- Bright, sunlight-readable 7" (17.8 cm) touchscreen.
- Transducer not included, provides GPS function only.
- Features a quick-release bail mount for quick installation and removal.
- Preloaded worldwide basemaps and compatible with Bluechart® G3 coastal charts (sold separately)
- Share data and maps with select ECHOMAP devices on your network.
- Use built-in Wi-Fi® to pair with the free ActiveCaptain™ app for access to OneChart™, smart notifications¹, Garmin Quickdraw™ Community data and more.
- Standard on FishPro Trophy model.

NEW Garmin [†] GT15M-IH Transducer		295100972
--	--	------------------



- Garmin's GT15M-IH In-Hull Mid-band CHIRP Transducer provides accurate depth readings even at high speed.
- Ideal for watercrafts that want to install the transducer inside a fiberglass hull and not on the transom.
- It can be used with a hull deadrise angle between 0 and 25 degrees and is excellent for watercrafts traveling at high speeds.
- In-Hull installation, no need to drill through the vessel; no drag.
- The 8-pin transducer with 4 plastic tanks features mid-band CHIRP traditional sonar (85-165 kHz) and has a power rating of 600 W.
- Requires Garmin[†] ECHOMAP™ UHD 72sv or 62cv GPS.
- Standard on FishPro Trophy model.

Garmin [†] ECHOMAP™ 62cv GPS with GT15M-IH Transducer	RXT, RXT-X, GTX, WAKE PRO (2019 and up) / GTI, GTI SE, GTR and WAKE 170 (2020 and up) / RXP-X (2021 and up)	295100921
--	---	------------------



- Bright, sunlight-readable 6" (15.2 cm) monitor.
 - Includes transducer for Garmin CHIRP traditional sonar.
 - GT15M-IH In-Hull Mid-band CHIRP Transducer provides accurate depth readings even at high speed.
 - Ideal for watercrafts that want to install the transducer inside a fiberglass hull and not on the transom.
 - Features a quick-release bail mount for quick installation and removal.
 - Preloaded worldwide basemaps and compatible with Bluechart® G3 coastal charts (sold separately).
 - Use built-in Wi-Fi to pair with the free ActiveCaptain¹ app for access to OneChart¹, smart notifications, Garmin Quickdraw¹ Community data and more.
 - Share waypoints and routes with other ECHOMAP or STRIKER¹ units.
 - Need harness (278003684) if installed with the BRP Audio-Premium System or with heated grips.
 - Standard on FishPro Sport and FishPro Scout models.
- *For 2018 models, see your certified BRP dealer to validate compatibility.

Garmin [†] ECHOMAP™ 62cv GPS	RXT, RXT-X, GTX, WAKE PRO (2019 and up) / GTI, GTI SE, GTR and WAKE 170 (2020 and up) / RXP-X (2021 and up)	295100871
---------------------------------------	---	------------------



- Bright, sunlight-readable 6" (15.2 cm) monitor.
 - Transducer not included, provides GPS function only.
 - Features a quick-release bail mount for quick installation and removal.
 - Preloaded worldwide basemaps and compatible with Bluechart® G3 coastal charts (sold separately)
 - Use built-in Wi-Fi to pair with the free ActiveCaptain¹ app for access to OneChart¹, smart notifications, Garmin Quickdraw¹ Community data and more.
 - Share waypoints and routes with other ECHOMAP or STRIKER¹ units.
 - Need harness (278003684) if installed with the BRP Audio-Premium System or with heated grips.
- *For 2018 models, see your certified BRP dealer to validate compatibility.

Secondary Battery Harness Kit

GTI, GTI SE, GTR and WAKE 170 (2020 and up) / FISHPRO SCOUT RXT, RXT-X, GTX and WAKE PRO (2018 and up) / FISHPRO (2019-2021), FISHPRO SPORT, FISHPRO TROPHY

295100990
295100991



(295100990 illustrated)

- Allows you to add a second unit to your dual battery setup.
- Will give you the extra juice you'll need to power electrical components like the BRP Audio-Premium System or Garmin Echomap GPS for longer periods.
- Kit includes necessary wiring and battery holder.
- Additional battery sold separately (410301203).

Battery Charger/Maintainer

715005061



- Fully automatic 3 Amp battery charger/maintainer.
- Keeps stored lead-acid batteries charged.
- Charges and maintains small batteries.
- Microprocessor controlled multi-stage charging for added precision, safety and battery life.
- Auto-voltage detection.
- Automatically detects 6 or 12 Volt batteries.
- Float mode monitoring automatically maintains optimum battery charge.
- Reverse hook-up protection helps protect battery and charger from damage.
- Hook attachment hangs outside the work area for safety and convenience.
- Display/on button.
- Press the display button to show the charge progress.
- Meets the highest industry standards for energy efficiency/eco friendliness.
- Content: 3 Amp battery charger, clamp adapter, DC adapter, 24" fused ring leads harness with weather cap, owner's manual.
- Not available in Europe

RF Programmable D.E.S.S.™ Key Kit

SPARK

295100945



- Digitally Encoded Security System (D.E.S.S.) key's ball-and-socket design provides riders with easy and quick starts every time.
- Anti-theft technology, the key communicates with the vehicle wirelessly, so the vehicle starts only when the key code matches the vehicle, for ultimate peace of mind.
- The RF Programmable D.E.S.S. Key can also be programmed to limit the speed of the watercraft enabling first time users and less experienced operators to learn how to operate while gaining the necessary confidence and control.
- Can be used as replacement key or second key.
- Includes RF programmable D.E.S.S.™ Key and D.E.S.S. post.
- Unlike previous D.E.S.S. Key kits, harness now sold separately.

Part numbers you will also need for installation:

- SPARK without iBR*: 278003491
- SPARK with iBR: 2017 and prior: 278003490 2018 and up: 278003823
- SPARK TRIXX: 2017 and prior: 278003490 and 278003195 2018 and up: 278003823 and 278003195

*Intelligent Brake and Reverse (iBR).

RF programmable D.E.S.S.™ Key

All vehicles with D.E.S.S. key (2015 and up)

278003401 Green (Learning Key)
278003400 Yellow
278003402 Black
278003403 Orange



- Digitally Encoded Security System (D.E.S.S.) key's ball-and-socket design provides riders with easy and quick starts every time.
- Anti-theft technology, the key communicates with the vehicle wirelessly, so the vehicle starts only when the key code matches the vehicle, for ultimate peace of mind.
- The RF Programmable D.E.S.S. Key can also be programmed to limit the speed of the watercraft enabling first time users and less experienced operators to learn how to operate while gaining the necessary confidence and control.
- Color options facilitate the differentiation between the programmed keys.
- Can be used as replacement key or second key.

Programmable D.E.S.S.™ Key

DI and 4-TEC models (2014 and prior)
All models (2014 and prior)

278002203 (Learning Key)
278002199



- Digitally Encoded Security System (D.E.S.S.) key snaps on easily on the vehicle and provides riders easy and quick starts every time
- Anti-theft technology, the key communicates with the vehicle wirelessly, so the vehicle starts only when the key code matches the vehicle, for ultimate peace of mind.
- The Programmable D.E.S.S. Key can also be programmed to limit the speed of the watercraft enabling first time users and less experienced operators to learn how to operate while gaining the necessary confidence and control.
- Can be used as replacement key or second key.

CTEK BRP 5.0 Charger

860200997



12-Volt Outlet and Installation Kit



SPARK / GTI, GTS, GTR, WAKE 155 (2019 and prior) / RXP-X (2020 and prior)	295100577
GTX and RXT without suspension (2015 and prior) / WAKE PRO (2015 and prior)	295100612*
GTX and RXT without suspension and WAKE PRO (2016-2017)	295100675*

- Use this 12V outlet to charge your phone or GPS unit.
- Equipped with waterproof cover to prevent water infiltration.

Ski and X Package Module
(Not illustrated)

RXT, RXT-X, GTX, GTX Ltd, WAKE PRO (2018 and up) / GTI (2018-2019) / GTI SE, GTI LTD, GTR, WAKE (2018 and up) / All FISHPRO models (2019 and up)	295100857
--	------------------

- One module that includes both Ski and X Package functions:
- Activates X package functions on gauge. See Xpackage module description to find out what are the X features that it unlocks on your vehicle.
- Activates ski mode: Offers a choice of different preset acceleration curves for perfect launch every time when towing a skier or wakeboarder, plus steady tow speed.
- User-friendly interface on gauge.
- Simple plug-in connection.
- Includes hardware necessary for installation.

X Package Module
(Not illustrated)

RXT, GTX, GTX Ltd, WAKE PRO (2018 and up) / GTI (2018-2019) / GTI SE, GTI LTD, GTR, WAKE (2018 and up) / All FISHPRO models (2019 and up)	295100757
---	------------------

- User-friendly interface on gauge.
 - Simple plug-in connection.
 - Includes hardware necessary for installation.
- Note: Harness (278002569) and 3 amps. fuse (710001008) are required to install on 2011 to 2017 models*
- For GTX, RXT and WAKE PRO (2018 and up), GTI, GTS, GTR and WAKE 155 (2020 and up) the features are:
- Average and top speed/RPM display unlocks launch mode control and the complete VTS range (50% more range)
- For GTI, GTS, GTR and WAKE 155 (2011-2019) the features are:
- Lap timer, fuel time and distance to "empty", average and top speed/RPM display and engine temperature.

Ski Module
(Not illustrated)

GTI (2018-2019) / GTI SE, GTI LTD, GTR (2018 and up) / RXT, RXT-X, GTX LTD (2018 and up)	295100756
--	------------------

- Activates ski mode.
 - Offers a choice of different preset acceleration curves for perfect launch every time when towing a skier or wakeboarder, plus steady tow speed.
 - User-friendly interface on gauge.
 - Simple plug-in connection.
 - Includes hardware necessary for installation.
- Note: Harness (278002569) and 3 amps. fuse (710001008) are required to install on 2011 to 2017 models.*

DEPTH FINDERS

- Display the water depth below the hull.
- Plug-and-play connection.
- Standard on GTX Ltd models.

MODEL	YEAR	SKU
SPARK	2014 and up*	295100679
GTI 90, GTS 90 [Polytec Hull]	2017-2019*	295100679
GTI, GTR, GTR-X [Fiberglass Hull]	2011-2017	295100679
	2018-2019	295100927
GTI [Polytec Hull]	2019**	295100927
WAKE	2011-2017	295100679
	2018-2019**	295100927
GTI 90*, GTI 130, GTI SE, GTR, WAKE 170	2020 and up	295100872
GTX	2011-2017	295100679
	2018 and up	295100927
GTX iS/S/aS	2011-2017	295100679
GTX LTD	2011-2017	295100679
	2018 and up	295100927
RXT, RXT-X	2011-2017	295100679
	2018 and up	295100927
RXT iS, RXT-X aS	2011-2016	295100679
RXP, RXP-X	2012-2017	295100679
	2018 and up	295100927
WAKE PRO	2011-2017	295100679
	2018 and up	295100927

*Electric Connection Kit (295100599) required for installation.

**Mounting bracket (278002495) required for installation.

BILGE PUMP KITS

- Keeps engine compartment dry for added peace of mind.
- Includes all necessary items for installation (bilge pump, mounting bracket, bilge fitting, hose and hardware).
- Plug and play installation: Plugs directly to watercraft fuse box.

MODEL	YEAR	SKU
SPARK	2014 and up	295100497
GTI, GTI SE, GTS, GTR [Fiberglass hull]	2011-2019	295100681
GTI, GTS [Polytec Hull]	2011-2019	295100497
WAKE	2011-2017*	295100681
	2018-2019	295100497
	2020 and up	295101035
GTI, GTI SE, GTR	2020 and up	295101035
FISHPRO (All models)	2019 and up	295101035
GTX	2010-2015**	295100681
	2016-2017	295100678
GTX, GTX LTD	2018 and up	295101035
RXT, RXT-X	2010-2015**	295100681
	2016-2017	295100678
	2018 and up	295101035
RXP-X	2012-2015**	295100681
	2016-2017	295100678
	2021 and up	295101035
WAKE PRO	2010-2015**	295100681
	2016-2017	295100678
	2018 and up	295101035

For 2014 and 2015** models, see your certified BRP dealer to match the right kit to your watercraft.

Electric Connection Kit

All SPARK models, GTI 90 (2017 and up)	295100599
--	------------------



- A very convenient and safe way to add electrical accessories.
- Plug-and-play connection.
- Required in order to install the Depth Finder on specific models (Refer to the Depth Finders table).

Body accessories



Ergolock Knee Pads	RXT, RXT-X, GTX and WAKE PRO (2018 and up) / FISHPRO (2019-2021), FISHPRO SPORT, FISHPRO TROPHY	295100744 Silver
	RXT, RXT-X, GTX and WAKE PRO (2018 and up) / FISHPRO (2019-2021), FISHPRO SPORT, FISHPRO TROPHY	295100804 Black
	SPARK	295100810 Black



- Allow you to rest your knees on a comfortable pad.
- Help keep your legs locked in place on the Ergolock System.
- To be combined with the Floorboard Wedges for improved balance on the vehicle.

Floorboard Wedges	RXT, GTX and WAKE PRO (2018 and up) / FISHPRO (2019-2021), FISHPRO SPORT, FISHPRO TROPHY, Standard on RXT-X (2018 and up)	295100745
	GTI, GTI SE, GTR, WAKE 170 (2020 and up) / FISHPRO SCOUT, Standard on RXP-X (2021 and up)	295100926
	SPARK	295100875



- Designed for high performance riding, extended angled floorboard wedges will keep all riders and passengers firmly planted, comfortable and secure.
- When used in conjunction with our Ergolock Knee Pads, the wedges ensure everyone can enjoy the full capabilities of the watercraft.

Angled Gunwale Footrests	RXT, RXT-X, GTX and WAKE PRO (2018 and up)	295100793
---------------------------------	--	------------------



- 4' long angled footrests with integrated mats, fixed on the upper outside edge of the footwell on each side of the watercraft.
- Provide a comfortable and secure position for the feet and legs while fishing from the side of the watercraft.
- Protect the paint finish on the edge of the footwells from abrasion caused by fishing.
- Standard on FISHPRO models.
- Not compatible with Wakeboard Holder.

Side Protectors	SPARK	295100575
------------------------	-------	------------------



- This 6-piece rubber formed protectors are specifically designed for the SPARK.
- Its curves and angles follow the lines of the watercraft to enhance the look while protecting it from small impacts and wear.
- Doesn't get in the way of Snap-in Fenders or any maintenance you need to perform.

Mirrors	SPARK	295100881
----------------	-------	------------------



- Durable and rugged construction for withstanding rough riding conditions.
- Perfectly integrated to the vehicle.
- Convex lens for wide angle view.
- Sold in pairs.

Comfort Seat	SPARK 2up	295100893
---------------------	-----------	------------------



- Seat specially designed to increase riding comfort on extended rides.
- Features a formed and larger sitting surface for better weight spread and stability in rough water.
- Constructed with soft foam.
- Direct replacement of the standard seat.

Comfort Seat	SPARK 3up	295100894
---------------------	-----------	------------------



- Seat specially designed to increase riding comfort on extended rides.
- Features a formed and larger sitting surface for better weight spread and stability in rough water.
- Constructed with soft foam.
- Direct replacement of the standard seat.

Passenger Seat	RXP-X (2021 and up)	295100923
-----------------------	---------------------	------------------



- Only way to have a passenger on a stock RXP-X.
- Two grab options for passengers, side and middle.
- No tools required for installation – simply remove driver cushion, unclip base, clip on passenger seat.

Fishing Seat	RXT, RXT-X, GTX and WAKE PRO (2018 and up)	295100882
---------------------	--	------------------



- Designed for ease of movement from driver position to passenger for fishing.
- Optimized for fishing facing sideways with increased lateral stability when combined with the Angled Gunwale Footrests (295100793).
- Fits all watercraft colorations.

Docking



Snap-in Fenders	Fit on all watercraft	295100418
------------------------	-----------------------	------------------



- Protect your investment from dock damage with these easy to install and remove fenders designed specifically for Sea-Doo watercraft.
- Front and rear on the SPARK models ensure a solid mount in the optimal spot.
- The Snap-in Fenders float and the high-visibility orange color keeps them in sight.
- Requires Snap-in Fenders Installation Kit (295100550, 295100729 or 295100944) to install on models other than SPARK.
- Patent pending.
- Sold in pairs.

Snap-in Fenders Installation Kit	RXP-X (2012-2020) / GTI, GTR and GTS (2011-2019) / GTX, RXT, RXT-X and WAKE PRO (2010-2017)	295100550
---	---	------------------



- Lets you enjoy the fastest, easiest way to install protective fenders on your watercraft.
- Not required for SPARK models.

Snap-in Fenders Installation Kit	RXT, RXT-X, GTX and WAKE PRO (2018 and up) / FISHPRO (2019-2021), FISHPRO SPORT, FISHPRO TROPHY	295100729
---	---	------------------





- Lets you enjoy the fastest, easiest way to install protective fenders on your watercraft.
- Not required for SPARK models.

Snap-in Fenders Installation Kit	GTI, GTR and WAKE 170 (2020 and up) / RXP-X (2021 and up) / FISHPRO SCOUT	295100944
---	---	------------------



- Lets you enjoy the fastest, easiest way to install protective fenders on your watercraft.
- Not required for SPARK models.

Speed Tie	GTX, RXT, RXT-X, WAKE PRO (2018 and up)	295100885
	<ul style="list-style-type: none"> Fully-integrated watercraft mooring system, providing the ultimate in convenient, quick and secure docking. A must-have accessory that frees up storage space and ensures you have a dock line at all times. 	<ul style="list-style-type: none"> Easy to use, integrated rope management system. ¼ inch (6.4 mm) double braided rope, 5.2 feet (1.6 m) at front and 9 feet (2.8 m) at rear. Positive locking for worry-free docking.

Speed Tie	FISHPRO (2019-2021), FISHPRO SPORT, FISHPRO TROPHY	295100924
	<ul style="list-style-type: none"> Fully-integrated watercraft mooring system, providing the ultimate in convenient, quick and secure docking. A must-have accessory that frees up storage space and ensures you have a dock line at all times. 	<ul style="list-style-type: none"> Easy to use, integrated rope management system. ¼ inch (6.4 mm) double braided rope, 11.5 feet (3.5 m) at front. Positive locking for worry-free docking.

Speed Tie	SPARK GTR (2012-2019) / GTI, GTI SE and GTS (2011-2019) / GTX without suspension (2010-2017) / WAKE PRO (2017 and prior) / RXT and RXT-X without suspension (2010-2017) / WAKE 155 (2010-2019)	295100496 295100680*
	<ul style="list-style-type: none"> Fully-integrated watercraft mooring system, providing the ultimate in convenient, quick and secure docking. A must-have accessory that frees up storage space and ensures you have a dock line at all times. 	<ul style="list-style-type: none"> Stores 5 ½' (1.7 m) of rope and locks to desired length. Standard equipment on the GTX Ltd models (2017 and prior). Sold in pairs.

Speed Tie for Dock <i>(Not illustrated)</i>		295100336
	<ul style="list-style-type: none"> Same exclusive mooring system available as a watercraft accessory, adapted for dock mounting. Provides quick and secure mooring for all watercraft, eliminating excessive rope on deck. 	<ul style="list-style-type: none"> Bolts directly to dock. Stores 5 ½' (1.7 m) of rope and locks to desired length. Sold individually.

Folding Anchor		295100750
	<ul style="list-style-type: none"> 3.5 lb (1.6 kg) grapnel folding anchor with protective coating. Perfect for temporary mooring of watercraft and small boats in mud, sand, gravel, and rock. 	<ul style="list-style-type: none"> Includes a 25' (7.62 m) marine grade rope with an in-line buoy, heavy-duty stainless steel snap hook, and a nylon storage case. Compact enough for the storage compartment.

Sandbag Anchor		295100661 Yellow
	<ul style="list-style-type: none"> Made of 600-denier solution-dyed yellow polyester fabric capable of holding an estimated 45 lb (20 kg) of wet sand. Measures 15 ¾" x 9" (40 cm x 22.9 cm). 	<ul style="list-style-type: none"> 16' half-inch nylon strap (4.9 m x 1.3 cm). Plastic hook attachment and molded floater.

Dock Tie		295100851
	<ul style="list-style-type: none"> Moor your watercraft with this floating Sea-Doo shock cushioned nylon rope. Provides security to keep your watercraft and dock attached. One per package. 	

Manual Reverse Kit	SPARK without iBR	295100596
	<ul style="list-style-type: none"> This kit can be easily added to your SPARK and will help immensely in docking maneuvers and trailer loading. A lever located on the left side makes it easy to engage reverse and avoid the need for aggressive or dangerous maneuvers. 	

Fender		295100877
	<ul style="list-style-type: none"> Polyform strength and dependability with a vinyl valve system for quick, flexible adjustment of firmness. One 16" fender and one rope per package. 	

Riding Essentials

Safety Equipment Kit		295100330
	<ul style="list-style-type: none"> This kit includes all the essentials for your watercraft. 50' (15 m) of buoyant heaving line, bailer, whistle and watertight flashlight. 	

Whistle		295500554
	<ul style="list-style-type: none"> Pea-less whistle. Produces an extremely loud, high, penetrating sound that can be heard over long distances. Unaffected by water; just clear with one quick blow. 	

Fire Extinguisher		295100833 White
	<ul style="list-style-type: none"> A requirement for any watercraft. Designed to fit in any fire extinguisher case holder. Ideal for grease, oil and electrical fires. US and Canadian Coast Guard approved. Not EC compliant 	

Registration Kit	3" (7.6 cm) All watercraft	295100570 Black
	3" (7.6 cm) All watercraft	295100578 Light Grey
	4" (10.2 cm) All watercraft · Meets international laws.	295100631 Black
	<ul style="list-style-type: none"> High-quality UV-resistant registration kit. Easy to install without deformation, with a glue that will adhere to all surfaces, including SPARK. Available in two contrasting colors that meet mandatory regulations for height and size. 	

Blank Sheet for Stickers <i>(Not illustrated)</i>		295100654 White
	<ul style="list-style-type: none"> Apply this self-adhesive sheet on your vehicle so you can add your own regional or other personalized stickers. 	

*While supplies last.

Covers

NEW All-Climate Storage Cover

GTX, RXT-X, WAKE PRO (2019 and up) / GTI, GTR, WAKE (2020 and up) / RXP-X (2021 and up) / All FISHPRO models (2019 and up)
SPARK 2up, SPARK 3up

295100901
295100905



- Protects watercraft surfaces from elements, dust, dirt, sun fading and more during storage.
- 100% waterproof plastic extrusion construction.
- Fused seams prevent leaking during rain or snow.
- Air vents allow circulation and prevent moisture build up.
- Soft inner lining protects watercraft from abrasion.
- Specifically designed for the perfect fit for easy installation and removal.
- Ideal replacement for shrink wrap storage for an eco-friendly solution.

*Not for use during trailering.

Covers Key Features

- Weather-resistant trailering cover protects your watercraft during storage and transportation.
- Made of heavy-duty UV-resistant solution-dyed polyester canvas.
- Soft inner lining prevents panel abrasion.
- Areas prone to higher wear are reinforced with a layer of double canvas.
- A perfect fit for your watercraft, with or without installed Sea-Doo accessories.
- Standard on GTX LTD models.



- 1 Yellow fabric indicates handle insertion points.
- 2 Zippered openings allow easy access to mooring cleats.
- 3 Zippered opening permits easy access to the glove box 3.1, front storage 3.2 and for refueling 3.3.
- 4 Zippered opening accommodates LinQ accessories on the rear deck with the cover in place.
- 5 Patented air release vent system for trailering.
- 6 Side hooks secure the cover while trailering.
- 7 Zippered opening allows the use of tie-downs for securing covered watercraft on the trailer.
- 8 Speed tie ready.
- 9 FISH finder and GPS ready.

Features may vary depending on watercraft model cover.

MODEL	1	2	3.1	3.2	3.3	4	5	6	7	8	9	COLORS	SKU
GTX, RXT models with suspension	GTX S, GTX Limited S (2012-2017)	●	●				●	●	●	●		Black/ Light Grey	295100718
	RXT iS, GTX iS, GTX Limited iS (2009-2016)	●	●				●	●	●	●		Black/ Light Grey	280000460
	RXT-X aS (2011-2016)	●	●				●	●	●	●		Black/ Light Grey	280000586
GTX, RXT, WAKE PRO, FISHPRO models without suspension	RXT, RXT-X, GTX, WAKE PRO (2018 and up)	●	●	●	●	●	●	●	●	●	●	Black	295101014
	GTX S, GTX Limited, RXT, RXT-X (2010-2017)	●	●				●	●	●	●		Black/ Light Grey	295100719
	WAKE PRO (2010-2017)	●	●				●	●	●	●		Black	295100720
	FISHPRO SPORT, FISHPRO TROPHY	●	●	●	●	●	●	●	●	●	●	Black	295100925
RXP-X, GTR-X models	RXP-X (2012-2020)	●	●				●	●	●	●		Black/ Light Grey	295100721
	GTR-X (2017-2019)	●	●				●	●	●	●		Black/ Light Grey	295100721
	RXP-X (2021 and up)	●	●	●	●	●	●	●	●	●		Black/ Light Grey	295100889
GTS, GTI, GTR, WAKE models, FISHPRO SCOUT	GTS, GTS Rental, GTI, GTI SE, GTI Limited (2011-2019)	●	●				●	●	●	●		Black/ Light Grey	295100722
	GTR (2012-2019)	●	●				●	●	●	●		Black/ Light Grey	295100723
	WAKE (2011-2019)	●	●				●	●	●	●		Black	295100724
	GTI, GTI SE, GTR, WAKE 170 (2020 and up) / FISHPRO SCOUT	●	●	●	●	●	●	●	●	●	●	Black	295100928
SPARK models	SPARK 2up	●	●	●	●	●	●	●	●	●		Black	295100912
	SPARK 3up	●	●	●	●	●	●	●	●	●		Black	295100789

Note: For prior model years, ask your dealer for details.



295100718
295100719
280000460
280000586



295101014



295100720



295100925



295100721
295100889



295100722
295100723



295100724



295100928



295100912
295100789

Cover Replacement Hooks

All models (2017 and up)

295100754



Cover Replacement Hooks

All models (2016 and prior)

295100407



Trailers

On the move

SEA-DOO Trailers are designed to fit all Sea-Doo watercraft and make loading and unloading a snap.



SEA-DOO SPARK CLICK & GO TRAILER

- Robust attachment, no need for separate supports
- Easy to use, clever, patented Click & Go locking mechanism
- Hinged light boom protects the lights during launch and removal
- No need for tie-down straps
- Safe design, soft design protects the craft and the user

Overall length	390 cm
Overall width	160 cm
Total weight (makes it possible to tow the trailer even with small vehicles)	400 kg

For all Sea-Doo Spark models
619590207 (without brake)
619590338 (with brake)



CLICK & GO TRAILERS Key Features

- ✓ Clever, patented Click & Go locking mechanism for Spark.
- ✓ No tie-down straps needed for securing the craft.
- ✓ Optimized for all Spark models (1+1 and 1+2), no need to adjust supports or the attachment.
- ✓ The total weight of the trailer (400 kg) makes it possible to tow it even with small vehicles.

Note: Please contact your nearest Sea-Doo dealer for suggested retail prices of trailers.

Single Trailers

SEA-DOO LOCK & GO TRAILER

- Patent Locking Mechanism for Sea-Doo watercraft
- Fits All Sea-Doo Watercraft except Sea-Doo Spark and Fish Pro
- No Tie-down need for securing the watercraft
- Soft Design Protects the watercraft and the user
- Unique rubber stopper in front to lock the watercraft in front
- Walkable mudguards make it easy to step on the watercraft

For all Sea-Doo watercraft models (except Sea-Doo Spark and Fish PRO)
860202384 (without brakes)
860202389 (with brakes)

Overall length	497 cm
Overall width	160 cm
Total weight (makes it possible to tow the trailer even with small vehicles)	700 kg



SEA-DOO BIG ONE TRAILER

- No need for separate supports
- Easy to use
- Securing the watercraft using tie-down straps
- Safe, soft design that protects the craft and the user
- Removable light rack
- Tip-up light rack

For all Sea-Doo watercraft models
619590223 (without brake)
619590337 (with brake)

Roller Kit For Big One
 (Not illustrated)
619590397

Overall length	447 cm
Overall width	160 cm
Total weight	600 kg



Redesigned PWC rubber stopper

Double Trailers

SEA-DOO BIG TWO TRAILER

- No need for separate supports
- Easy to use
- Securing the watercraft using tie-down straps
- Safe, soft design that protects the craft and the user
- Removable light rack
- Tip-up light rack

For all Sea-Doo watercraft models
619590586

Overall length	515 cm
Overall width	245 cm
Total weight	1,200 kg



TRAILERS Key Features	Single			Double
	SPARK CLICK & GO TRAILER	LOCK & GO TRAILER	BIG ONE TRAILER	BIG TWO TRAILER
Robust attachment	●	●	●	●
No need for separate supports	●	●	●	●
Easy to use	●	●	●	●
Clever, patented Click & Go locking mechanism	●	●	●	
Hinged light boom protects the lights during launch and removal	●	●	●	
No need for tie-down straps	●	●	●	
Safe design	●	●	●	●
Soft design protects the craft and the user	●	●	●	●
Securing the watercraft using tie-down straps			●	●
Removable light rack	●	●		
Tip-up light rack			●	●

Trailer Accessories

Bolt-On† Retractable Ratcheting Tie-Downs

- Perfect for transporting your watercraft or securing loads.
 - Mount easily: bolts on any flat surface (e.g. truck bed or frame).
 - 1" x 6' (2.5 cm x 1.83 m) tie-down strap with heavy-duty stitching that delivers a 500 lb (226 kg) working load strength and 1,500 lb (680 kg) break strength.
 - Convenient retractable push button automatically slackens, spools and stores away strap, while the ratchet mechanism tightens the strap snugly to secure your vehicle or load into place.
 - Rubber ratcheting handle provides firm grip, and the hook is vinyl-coated to protect whatever surface it hooks into.
 - Sold in pairs.
- 295100841**



Ratchet Tie-Downs

- Designed specifically for strapping a watercraft to a trailer.
 - Custom 4-hook system is ideal for quick installation/removal without separating strap from ratchet.
 - Fingertip tension adjustment with deluxe ratchet.
 - 1" (2.5 cm) Sea-Doo branded polyester strap features hull protector pads, extra strap holder and coated hooks.
 - Sold individually.
- All watercraft (except SPARK)
295100389



Ratchet Tie-Downs

- 400 lb (181 kg) safe working load.
 - 1" x 10' (2.5 cm x 3 m) strap with Sea-Doo, Ski-Doo and Can-Am logos.
 - Deluxe ratchet with rubber handle.
 - Coated S hooks.
 - Pack of 2.
- All watercraft
860200447



Some products may not be available or homologated in your region. Contact your dealer for more information.

Graphic Kits

Enjoy a wide range of combinations with any of our different graphic kits, available in 4 or 5 customization levels across multiple color themes.

BOLD CUSTOMISATION LEVELS

These Sea-Doo exclusive Attitude Graphic Kits let you customize your vehicle, whether for a simple facelift or because you want your watercraft to turn heads.

SPARK
5 Levels

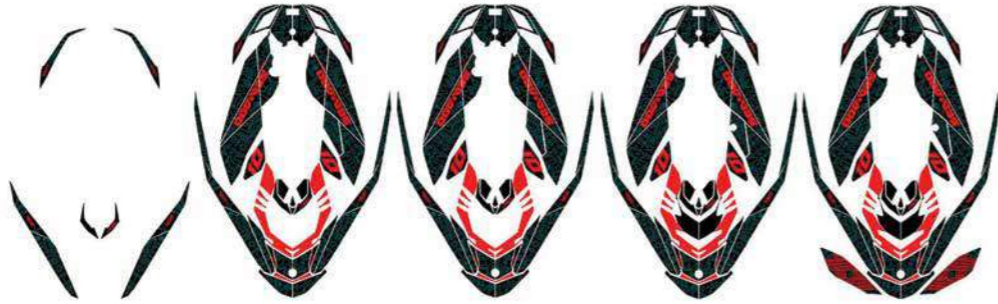

All Other Models
4 Levels



Customize your wrap coloration, design and even add registration numbers. For more details, see scsunlimited.com

NEW GRAPHIC KITS

RXT-X
Particles



GTX LIMITED
Big Boss



GTI
Tsunami



TWAKE
Sanctuary



WAKE PRO
Golden Hour



RXP-X
Heat



FISHPRO
Slayer



SPARK TRIXX
Launch



SPARK TRIXX
Icon









Parts & Maintenance

Parts & Maintenance

- 71 Replacement Parts
- 73 Performance Accessories
- 74 Maintenance Products
- 75 Engine Oils
- 76 Functionnal Fluids / Lubricants

Replacement Parts

Battery 18 amps (HTX20L-FA)	18 amps, Wet (HTX20L-FA)	296000441
	<ul style="list-style-type: none"> OEM Sea-Doo battery made from absorbed glass mat (AGM) offering longer storage life and better performance than standard wet batteries. 	<ul style="list-style-type: none"> A factory filled permanently sealed / non-spillable battery for maintenance free use.(no need to check levels or add water).
<hr/>		
Lift Kit	295100758	
	<ul style="list-style-type: none"> Accurately lifts and positions your watercraft with a lift kit of nylon webbing and vinyl-coated steel lift plates. Lifting capacity of 1,200 lb (544 kg). Allows lifting from both straight and angled positions. 	
<hr/>		
Sacrificial Anodes	Outside diameter: 26 mm. Height: 6 mm Outside diameter: 26 mm. Height: 13 mm	271001920 271001813
	<ul style="list-style-type: none"> Sacrificial anodes are specifically designed to protect parts of your personal watercraft that are underwater from galvanic corrosion. Like the name implies, they essentially "sacrifice" themselves by absorbing the electrochemical process of corrosion to prevent metal components like the impeller, jet pump nozzle or engine from being "eaten away" instead. 	<ul style="list-style-type: none"> Galvanic corrosion can cause major damage if not controlled. Inspect your sacrificial anode at least once a month. Replace it when it is 50% depleted.
<hr/>		
Sacrificial Anodes	1/4-18 NPT Anode for intercooler on models 260 and 300 hp (2016 and up).	271001942
	<ul style="list-style-type: none"> Sacrificial anodes are specifically designed to protect parts of your personal watercraft that are underwater from galvanic corrosion. Like the name implies, they essentially "sacrifice" themselves by absorbing the electrochemical process of corrosion to prevent metal components like the impeller, jet pump nozzle or engine from being "eaten away" instead. 	<ul style="list-style-type: none"> Galvanic corrosion can cause major damage if not controlled. Inspect your sacrificial anode at least once a month. Replace it when it is 50% depleted.
<hr/>		
Supercharger Repair Kit	Fits all 215, 255 and 260 hp models	420881102
	<ul style="list-style-type: none"> Complete kit to rebuild your supercharger. Made of quality Sea-Doo genuine parts and metal washers to increase reliability. <p><i>See your certified BRP dealer to match the right parts to your watercraft.</i></p>	

Sea-Doo limited warranty*
 1-Year on BRP Parts

*Purchased at an authorized BRP dealership/distributor or on a BRP-authorized online store. Unless otherwise stipulated or required by law. Other exclusions may apply. See complete limited warranty or contact your authorized Sea-Doo dealer. This limited warranty does not apply to factor-installed accessories.



IMPELLERS



High-performance impellers designed specifically to enhance engine performances and calibration. Offer perfect fit with wear ring and driveshaft components.

ENGINE	MODEL	YEAR	SKU
60/90	SPARK	2014 and up	267000948
	GTI GTS GTI SE 90	2017-2019	267000919
	GTI 90	2020 and up	267001046
130/155	GTI 130&155 GTI SE 130&155 GTS 130	2009-2019	267000940
	GTI 130 GTI SE 130	2020 and up	267001044
	GTI PRO GTX PRO	2020/2021	267001076
	WAKE 155	2011-2017 2018-2019	267000940 267001019
	GTX 155 GTX S 155	2011-2017 2018- 2019	267000943 267001019
	FISHPRO 155 FISHPRO SCOUT 130	2019 2022	267001019 267001044
170	GTI SE 170 GTX 170 WAKE 170 FISHPRO 170 FISHPRO SPORT 170 FISHPRO TROPHY 170	2020 and up	267001044
	GTR 215	2014-2016	267000801
	GTX 215 GTX LTD 215 WAKE PRO 215	2011-2016	267000756
	GTR 230 GTR-X 230	2017-2019	267000957
230	GTX-LTD 230 WAKE PRO 230	2017	267000954
	GTX 230 GTX LTD 230 WAKE PRO 230 RXT 230	2018 2019	267001021 267001038
	GTX 230 GTX-LTD 230 WAKE PRO 230	2020 and up	267001045
	GTX LTD iS & S 260	2012-2016	267000945
255/260	RXP-X 255	2009-2011	267000994
	RXP-X 260	2012-2015	267000984
	RXT- X 260 RXT iS 255 & 260	2009-2010	267000974
	RXT 260 RXT AS 260 RXT iS 260	2011-2017	267000945
	GTX LTD RXT-X 300	2016 and up	267000951
	RXP-X 300 RXP-X	2016-2020 2021 and up	267000951 267001050

See your certified BRP dealer to match the right parts to your watercraft.

WEAR RINGS



- Simple, cost-effective way to keep the pump system operating like new.
- Restore tight clearance to your impeller.
- Reduce cavitation and recover lost performance caused by a worn ring.

MODEL	YEAR	SKU
SPARK	2014-2022	267000925
GTI 90	2017-2022	267000897
GTI SE 90	2017-2018	267000897
GTI PRO	2020	267001036
GTI/GTI SE 130	2009-2022	267000419
GTI SE 155	2009-2019	267000419
GTR 215	2012-2016	267000372
GTR 230 (all models)	2017-2022	267000917
GTS 90	2017-2019	267000897
GTS 130	2011-2016	267000419
GTS PRO 130 (Europe)	2011	267000419
GTS RENTAL 130	2014-2015	267000419
GTX 155	2009-2019	267000419
GTX S 155	2009-2017	267000419
GTX 170	2021-2022	267000419
GTX 215/255/260	2009-2017	267000372
GTX 230	2018 2019-2022	267000372 267000917
GTX Ltd 230	2017 -2021	267000917
GTX Ltd 300	2016 -2022	267000917
GTX PRO	2020	267001036
FISHPRO SPORT, FISHPRO SCOUT, FISHPRO TROPHY	2019-2022	267000419
RXP-X (all models, except 300 hp)	2009-2015	267000372
RXP-X 300	2016-2022	267000917
RXT (all models, except 300 hp)	2009-2018	267000372
RXT 230	2019	267000917
RXT-X 300	2016-2022	267000917
WAKE 155	2009-2019	267000419
WAKE 170	2021-2022	267000419
WAKE PRO 215	2011-2016	267000372
WAKE PRO 230	2009-2018	267000372
WAKE PRO 230	2019-2022	267000917

See your certified BRP dealer to match the right parts to your watercraft.

Performance Accessories



<p>Top-Loader Intake Grate</p>	<p>SPARK</p> <p>295100845</p> <ul style="list-style-type: none"> • Intake grate with unique wing design for enhanced acceleration and top speed. • Deep side rails improve straight line stability and handling. • Durable black race coating protects from corrosion. • IJSBA race legal. • Pump Seal Kit (295100846) is required to fully unlock the benefits of the grate. 								
<p>Pump Seal Kit</p>	<p>SPARK</p> <p>295100846</p> <ul style="list-style-type: none"> • Location specific, molded inserts fill voids in intake grate shoe that can bleed air into pump causing cavitation. • Allows for a positive seal for maximum performance. • Required when installing the Top-Loader Intake Grate (295100845). 								
<p>Pro-Series Sponson Kit</p>	<p>SPARK</p> <p>295100847</p> <ul style="list-style-type: none"> • Race proven Pro-Series Sponsons will dramatically improve the handling of your watercraft with their superior blade and backing plate design. • Includes a bulletproof mounting system that features a solid backing plate and four anchor points with billet aluminum inserts in sponson fins. • Sponson depth is adjustable to control the amount of influence they have on the craft. • Easy installation, uses original mounting studs. 								
<p>Front and Rear Deck Hardware Upgrade Kit</p>	<p>SPARK</p> <p>295100849</p> <ul style="list-style-type: none"> • Includes 31 washers for front and rear deck, plus one extra washer. • Sturdy stainless steel washer kit directly replaces the original plastic deck washers. • Provides an awesome cosmetic upgrade along with increased durability. • Precision machined washers are electropolished, providing excellent fit and finish. • A must for repeatedly removing and replacing your deck for regular maintenance and inspection. 								
<p>Main Deck Hardware Upgrade Kit</p>	<p>SPARK</p> <p>295100848</p> <ul style="list-style-type: none"> • Includes 22 washers for main (center) engine access deck, plus one extra washer. • Sturdy stainless steel washer kit directly replaces the original plastic deck washers. • Provides an awesome cosmetic upgrade along with increased durability. • Precision machined washers are electropolished, providing excellent fit and finish. • A must for repeatedly removing and replacing your deck for regular maintenance and inspection. 								
<p>Stainless Steel Wear Ring</p>	<table border="1"> <tr> <td>230 hp (2020 and up), 300 hp (2016 and up)</td> <td>267001060</td> </tr> <tr> <td>GTI, GTS, WAKE, GTX 130, 155 and 170 (2011 and up)</td> <td>267000800</td> </tr> <tr> <td>SPARK</td> <td>295100649</td> </tr> <tr> <td>GTR 215 (up to 2016), RXT and GTX 260 (2009-2017), RXT and GTX 230 (2017-2018), RXT and GTX 215 (2009-2017)</td> <td>296000431</td> </tr> </table> <ul style="list-style-type: none"> • Strong and durable stainless steel replacement wear ring. • Resists debris damage and corrosion. • Recommended if watercraft usage includes frequent beaching or shallow and swift water riding. • Direct replacement and easy press-in installation. <p><i>Note: Please contact your nearest Sea-Doo dealer for suggested retail prices of those products.</i></p>	230 hp (2020 and up), 300 hp (2016 and up)	267001060	GTI, GTS, WAKE, GTX 130, 155 and 170 (2011 and up)	267000800	SPARK	295100649	GTR 215 (up to 2016), RXT and GTX 260 (2009-2017), RXT and GTX 230 (2017-2018), RXT and GTX 215 (2009-2017)	296000431
230 hp (2020 and up), 300 hp (2016 and up)	267001060								
GTI, GTS, WAKE, GTX 130, 155 and 170 (2011 and up)	267000800								
SPARK	295100649								
GTR 215 (up to 2016), RXT and GTX 260 (2009-2017), RXT and GTX 230 (2017-2018), RXT and GTX 215 (2009-2017)	296000431								
<p>Anti-Debris Water Intake Grate</p>	<p>GTI, GTS and WAKE (2011-2019)</p> <p>271001948</p> <ul style="list-style-type: none"> • Protects jet pump assembly and cooling system by blocking rocks and debris larger than 0.39" (10 mm). • Helps avoid damage and premature wear of the impeller and the wear ring. • Also helps reduce algae accumulation. • Recommended if watercraft usage includes frequent beaching or shallow and swift water riding. • Expect a slight performance reduction. 								

Maintenance Products

Salt-Away[†]	295100219 Refill 1 US gal. (3.785 L)
	295100220 Refil 1 quart (946 ml)
	295100218 Concentrate with dispenser 1 quart (946 ml)



- Mixed with water, it washes away the salt and leaves a protective coating on the surface to prevent rust and corrosion.
- Can also be used for trailer wash and maintenance.

Salt-Away[†] - Dispenser Unit	295100221
---	------------------



Flush Kit	SPARK (Standard on 2015 and up models)	295100555
	For watercraft that do not yet have a "T" fitting and don't have the threaded water outlet on the ride shoe.	295500068



- A must to help keep your engine corrosion-free and to maximize performance.
- Kit includes all necessary components for a hassle-free flush.

Flush Adapter	295500473
----------------------	------------------



- For most watercraft models with a threaded water outlet fitting on the ride shoe.

Coupler Hose	295500258
---------------------	------------------



- For most watercraft models that already have a "T" fitting.
- Also for watercraft models that use the flush adapter on the ride shoe water outlet

NGK[†] Spark Plugs	DCP-R8E	707000246
	KR9E-G	296000421
	CR8EB	415129403



- BRP dealers carry the full line of premium NGK Spark Plugs for Sea-Doo watercraft.

Oil Filter	420956123 Rotax 900 ACE engine
	420956744 Rotax 1500 cc or more engine



- Ask your certified BRP dealer to match the right parts to your watercraft.

Oil Vaccum Tool	295100244
------------------------	------------------



- Safely and easily removes engine oil.
- Activate with a power drill.

Handpump with container	529035880
--------------------------------	------------------



Engine Oils

XPS 4T 5W-40 Synthetic Blend Oil Change Kit	779250 Rotax 900 ACE engine
	779251 Rotax 1500 cc or more engine



- Ultra-convenient "all-in-one" oil change kit saves time and money.
- Includes XPS Synthetic Blend Oil, oil filter, o-rings and washer.

XPS 4T 5W40 Synthetic Blend Oil	779133 (US) / 779290 (EU) 1 qt. / 0.946 L
	779134 (US) / 779291 (EU) 1 US gal. / 3.785 L



- Designed for high-performance off-road, on-road and PWC 4-stroke engines, including turbo or supercharged powersports engines.
- Off-road formula with premium antiwear and anti-corrosion additives.
- Provides superior engine and transmission protection against rust and corrosion even in extreme conditions.

XPS 2T E-TEC Synthetic Oil

779281 1 quart (0.946 L)
779282 1 US gal. (3.785 L)



- Specifically engineered to meet the unique needs of Rotax engines, it provides maximum protection against engine wear in E-TEC engines.
- Uses a highly effective package to keep engine parts lubricated, clean and free of wear.
- This low smoke, low odor formula also allows for maximum engine performance.
- Can be used in direct, semi-direct fuel injection system and high performance carbureted 2-stroke engines.

XPS 2T Racing Synthetic Oil

779180 1 qt. / 0.946 L
779181 (US) / **779229** (EU) 1 US gal. / 3.785 L



- Designed for all fuel injection, carbureted, oil injection or premix 2-stroke personal watercraft.
- Provides low smoke, easy cold starting.
- Ensures maximum protection against corrosion and wear by keeping engine parts lubricated and clean.

Functionnal Fluids



Extended Life Pre-Mixed Coolant

779150 / 619590204 (Scandinavia)
1 qt. / 0.946 L



- Antifreeze/Coolant contains the correct dilution and the necessary additives to prevent corrosion and inhibit cavitation in BRP cooling systems.
- Long-life, 5-year formula specially formulated for BRP vehicles.
- Superior heat transfer.
- Ideal replacement for vehicles that normally use a 2-year antifreeze/coolant (green).
- 5 years (orange).

Lubricants



Synthetic Grease

293550010 14 oz. / 400 g



- Recommended for marine applications.
- This synthetic grease provides the best wear protection and water resistance available.

Synthetic Jet Pump Oil

779221 6 fl. oz. / 178 ml



- Synthetic Jet Pump Oil uses a unique combination of synthetic base stocks and additives that allow higher loads, superior shear stability and reduced oxidation compared to other synthetics and conventional API GL-5 oils.
- Recommended for use in Sea-Doo jet pump requiring oil.

Triple-Guard[®] Marine Grease

296000329 8 oz. / 227 g



- This tough grease stays in place and is unaffected by vibration, salt water or cold temperatures.
- Reformulated for high water resistance and improved adhesion to metal.
- Won't swell seals, packing or o-rings.
- Totally waterproof to prevent water wash-off.

Anti-Corrosive Lubricant

779167 / 619590093 (Scandinavia)
14 oz. / 400g



- Multipurpose lubricant that can also be used to prevent rust, corrosion and moisture intrusion.
- It contains extreme pressure additives that work as an all-around lubricant for just about anywhere lubrication is needed.

Anti-Corrosion Spray

219700304 11 oz. / 312 g



- Heavy, waxy coating specifically designed to protect your engine from rust and corrosion.
- Highly effective against corrosion caused by salt water and salt spray.

XPS Storage Oil

779173 / 619590094 (Scandinavia)
12 oz. / 350 g



- High-performance fogging oil designed to protect internal engine parts from rust and corrosion.
- It coats engine internals throughout out the whole storage period and is burned away through combustion when engine is started.
- Protects engines during non-use or storage.
- Burns complete upon start up.

Fuel Stabilizer

779171 (US) / **779183** (EU)
8 fl. oz. / 236 ml



- Ethanol-compatible and will stabilize fuel in your tank to keep it from breaking down and causing hard starting, throttle hesitation and poor run quality.
- Ethanol attracts moisture, and this product contains powerful anti-corrosion additives to protect fuel system components.
- Prevents problems associated with E10 fuels.

Fuel Treatment Carbon Free

779169 12 fl. oz. / 355 ml



- Combination of a fuel treatment and a fuel system cleaner that can be used periodically to restore lost starting or throttle performance, as well as maintain fuel system integrity and keep internal engine parts clean.
- It treats fuel for storage and addresses the moisture problems inherent in today's Ethanol-blended fuels, keeping ferrous and soft metal parts clean and free of corrosion.
- Uses patented, state-of-the-art additives.
- Cleans valves, sticky rings and combustion chamber.

Fuel Treatment Carburetor Cleaner

779172 (US) / **779184** (EU)
12 fl. oz. / 355 ml



- Complete fuel treatment specially formulated to prevent small engine problems caused by Ethanol-blended fuels.
- It removes fuel system gum and varnish that may have accumulated during storage, stabilizes fuel against breakdown for 12 months or more, and adds corrosion protection from moisture for short- and long-term storage.
- It also helps restore throttle response and easy starting.
- It can be used periodically to maintain fuel system integrity, keep carburetor jets clean, and also combat moisture problems caused by Ethanol-blended fuels to keep ferrous and soft metal parts clean and free of corrosion.



Apparel



Apparel

- 80 What do you need to wear on the water
- 81 Airflow PFD
- 82 Explorer PFD
- 83 PFD decision guide
- 84 Neoprene decision guide
- 85 Personal Flotation Device
- 89 Rashguards
- 91 Wetsuits
- 94 Dry Suits
- 95 Eyewear
- 96 Handwear
- 97 Footwear
- 98 Sportswear
- 104 Sizing Chart
- 105 Notes



What do you need to wear on the water

Eyewear UV eyewear that stays secure on your ride and protects you from splash and spray.



PFD to keep you afloat during your ride.



Protective Bottoms: Undershorts or a neoprene bottom for protection from sun and water intrusion.



UV protection: Hats, caps, rashguards and neck rags for sun and splash protection.



Gloves: for better grip and hand protection.



Airflow PFD



- 1 **Airflow System:** keeps the life jackets surface away from the skin for a dryer more comfortable ride.
- 2 **Lumbar Comfort Zone:** Extra padding to minimize the pressure on your lower back and bolstering support.
- 3 **Mesh Panel:** Drain away excess water for quick drying and thermal regulated comfort.
- 4 Side panels in stretch lining fabric for improved mobility.
- 5 Durable YKK front zipper.
- 6 Armholes cut large for riding comfort.
- 7 Environmentally friendly ecoprene material.
- 8 Coast Guard approved

Explorer PFD

- 1 Reflective details for better visibility and security whenever the time of the day.
- 2 Heavy-duty Rip-stop Nylon material.
- 3 Durable YKK front zipper.
- 4 Armholes cut large for riding comfort.
- 5 Camera mount.
- 6 Whistle for better safety.
- 7 Multiple pockets for more storage during your adventure.
- 8 Handheld VHF radio holder.
- 9 Segmented foam at back bottom for increased comfort while seated.
- 10 Coast Guard approved.



PFD decision guide



Airflow

For ultimate comfort

Top selling point	<ul style="list-style-type: none"> Lightweight and Quick dry. Airflow construction for extra breathability. Eco friendly materials.
M/F/U/T/K	M/F
Material	<ul style="list-style-type: none"> Ecoprene Shell. PVC free Gaia foam.



Freedom

For freedom of movement

Top selling point	<ul style="list-style-type: none"> Lightweight and Quick dry. Eco friendly materials.
M/F/U/T/K	M/F
Material	<ul style="list-style-type: none"> Ecoprene shell. PVC and PE foam inserts.



Explorer

For any adventure

Top selling point	<ul style="list-style-type: none"> Storage for your adventures. Super durable material. Camera mount.
M/F/U/T/K	U
Material	<ul style="list-style-type: none"> Heavy-duty Rip-stop Nylon material. Polyethylene foam inserts.



Motion

Durable yet comfortable

Top selling point	<ul style="list-style-type: none"> Durable yet comfortable. Freedom of movement.
M/F/U/T/K	M/F
Material	<ul style="list-style-type: none"> Heavy-duty polyester material. Polyethylene foam inserts.



Navigator

The affordable option

Top selling point	<ul style="list-style-type: none"> Affordable. Entry level PFD.
M/F/U/T/K	U
Material	<ul style="list-style-type: none"> Heavy-duty polyester material. Polyethylene foam inserts.



Explorer JR

For your teen

Top selling point	<ul style="list-style-type: none"> Specially developed for teens. Lightweight quick dry. Ecofriendly material.
M/F/U/T/K	T
Material	<ul style="list-style-type: none"> Ecoprene shell. PVC and PE foam inserts.



Sandsea

For your kids

Top selling point	<ul style="list-style-type: none"> Protection for your young kids. Durable and safe.
M/F/U/T/K	K
Material	<ul style="list-style-type: none"> Heavy-duty polyester material. Polyethylene foam inserts.

Neoprene decision guide



Undershorts

Breathable lightweight, with integrated protection against elements

- Lightweight breathable fabric for warm weather.
- To be worn under your boardshorts
- Neoprene Protective panels for water intrusion protection.

Top selling point

M/F/U/T/K

M/F

Usage

- Warm weather.
- Water intrusion protection.



Neoprene shorts

Great protection against the elements

- Stretch neoprene fabric for all around protection from water intrusion.
- UV protection.

M/F

- Moderate weather.
- Water intrusion protection.



3 mm Escape Shorty Wetsuit

Great protection against the elements, built for speed

- Stretch neoprene fabric for all around protection from water intrusion.
- Suited for moderate to cooler temperatures.
- UV protection.

M/F

- Moderate weather.
- Performance speed protection.
- Water intrusion protection.



Montego Jacket & Pants

For layering on cold days or for ultimate protection for performance riders

- Stretch neoprene fabric for all around protection from water intrusion.
- Suited for high- speed impact protection or cooler temperatures.
- Athletic fit.

Top selling point

M/F/U/T/K

M/F

Usage

- Cold weather.
- Performance speed protection.
- Water intrusion protection.



Riding jacket

To be worn over you PFD for layering on colder days, and ultimate protection from the elements

- Stretch neoprene fabric for all around protection.
- Best used for layering over PFD on colder days.
- Relaxed fit.

M/F

- Cold weather.
- Performance speed protection.

Personal Flotation Device

MEN'S - PERSONAL FLOTATION DEVICE

NEW Men's Airflow Refraction Edition PFD



285966 (US)
285967 (EU)
S, M, L, XL, 2XL, 3XL

- Black with Graphics (94),
- Hi-Vis Yellow (26)

Descriptions:

- Soft and light PFD with a ultra-durable ecoprene outer shell and new Refraction design.

Features and technologies:

- Environmentally friendly ecoprene material that is rubber free, flexible, lightweight, breathable and quick dry.
- Vest interior constructed of eco-friendly 100% PVC-free Gaia foam.
- AIRFLOW SYSTEM: Interior EVA molding that keeps the life jackets surface away from the skin.
- LUMBAR COMFORT ZONE: Extra foam padding to minimize the pressure on your lower back while bolstering support.

- MESH PANEL: Drain away excess water for quick drying and thermal regulated comfort.
- Comfortable fit.
- YKK front zipper.
- Side panels in stretch lining fabric for improved comfort.
- Armholes cut large for riding comfort.
- Loop at back neck to attach your goggles to your vest.
- D-ring for key lanyard.
- Coast Guard approved.

Men's Airflow PFD



285938 (US)
285939 (EU)
S, M, L, XL, 2XL, 3XL

- Black (90)

Descriptions

- Soft and light PFD with a ultra-durable ecoprene outer shell.

Features and technologies

- Environmentally friendly ecoprene material that is rubber free, flexible, lightweight, breathable and quick dry.
- Vest interior constructed of eco-friendly 100% PVC-free Gaiafoam.
- AIRFLOW SYSTEM: Interior EVA molding that keeps the life jackets surface away from the skin.
- LUMBAR COMFORT ZONE: Extra foam padding to minimize the pressure on your lower back while bolstering support.

- MESH PANEL: Drain away excess water for quick drying and thermal regulated comfort.
- Comfortable fit.
- YKK front zipper.
- Side panels in stretch lining fabric for improved comfort.
- Armholes cut large for riding comfort.
- Loop at back neck to attach your goggles to your vest.
- D-ring for key lanyard.
- Coast Guard approved.

Men's Freedom PFD



285942 (US)
285943 (EU)
S, M, L, XL, 2XL, 3XL

- Black (90),
- Orange (12),
- Starlight Blue (84),
- Sunburst Yellow (96)

Descriptions

- PFD with a ultra-durable ecoprene outer shell.

Features and technologies

- Environmentally friendly ecoprene material that is rubber free, flexible, lightweight, breathable and quick dry.
- Combination of PVC and polyethylene foam inserts.
- LUMBAR COMFORT ZONE: Extra foam padding to minimize the pressure on your lower back while bolstering support.
- MESH PANEL: Drain away excess water for quick drying and thermal regulated comfort.
- Comfortable fit.

- YKK front zipper.
- Segmentations at front and back for better comfort and ease of movement.
- Side panels in stretch lining fabric for improved comfort.
- Armholes cut large for riding comfort.
- Loop at back neck to attach your goggles to your vest.
- D-ring for key lanyard.
- Coast Guard approved.

NEW Men's Motion PFD



286800 (US)
286801 (EU)
S, M, L, XL, 2XL, 3XL, 4XL

● Hi-Vis Yellow (26),
● Navy (89),
● Red (30)

Descriptions

- PFD with heavy-duty polyester outer shell.
- Heavy-duty polyester material.
- Polyethylene foam inserts.
- Segmented foam at back bottom for increased comfort while seated.

Features and technologies

- Armholes cut large for riding comfort.
- Loop at back neck to attach your goggles to your vest.
- Coast Guard approved.

UNISEX – PERSONAL FLOTATION DEVICE

NEW Explorer PFD



285964 (US)
285965 (EU)
XS, S, M, L, XL, 2XL, 3XL, 4XL

● Black (90)

Descriptions

- PFD made of Heavy-duty Rip-stop Nylon outer shell.
- Heavy-duty Rip-stop Nylon material.
- Polyethylene foam inserts.
- Segmented foam at back bottom for increased comfort while seated.
- Armholes cut large for riding comfort.
- Camera mount.

Features and technologies

- Whistle.
- Handheld VHF radio holder.
- Loop at back neck to attach your goggles to your vest.
- D-ring for key lanyard.
- Multiple pockets.
- Coast Guard approved.

Navigator PFD



285947 (US)
285948 (EU)
XS, S/M, L/XL, 2XL/3XL,
4XL/6XL

● Charcoal Grey (07),
● Navy (89)

Descriptions

- PFD with a ultra-durable polyester outer shell.
- Unisex value built PFD
- Polyethylene foam inserts.
- Dual-sized making it perfect for sharing
- Comfortable fit.

Features and technologies

- Armholes cut large for riding comfort.
- Loop at back neck to attach your goggles to your vest.
- D-ring for key lanyard.
- Coast Guard approved.

LADIES' – PERSONAL FLOTATION DEVICE

NEW Ladies' Airflow Refraction Edition PFD



285968 (US)
285969 (EU)
S, M, L, XL, 2XL, 3XL

● Deep Purple (42),
● Turquoise (Aqua) (76)

Descriptions

- Soft and light PFD with a ultra-durable ecoprene outer shell and new Refraction design.
- Environmentally friendly ecoprene material that is rubber free, flexible, lightweight, breathable and quick dry.
- Vest interior constructed of eco-friendly 100% PVC-free Gaia foam.
- AIRFLOW SYSTEM: Interior EVA molding that keeps the life jackets surface away from the skin.
- LUMBAR COMFORT ZONE: Extra foam padding to minimize the pressure on your lower back while bolstering support.

Features and technologies

- MESH PANEL: Drain away excess water for quick drying and thermal regulated comfort.
- Comfortable fit.
- YKK front zipper.
- Side panels in stretch lining fabric for improved comfort.
- Armholes cut large for riding comfort.
- Loop at back neck to attach your goggles to your vest.
- D-ring for key lanyard.
- Coast Guard approved.

Ladies' Airflow PFD



285940 (US)
285941 (EU)
S, M, L, XL, 2XL, 3XL

● Raspberry (39)

Descriptions

- Soft and light PFD with a ultra-durable ecoprene outer shell.
- Environmentally friendly ecoprene material that is rubber free, flexible, lightweight, breathable and quick dry.
- Vest interior constructed of eco-friendly 100% PVC-free Gaia foam.
- AIRFLOW SYSTEM: Interior EVA molding that keeps the life jackets surface away from the skin.
- LUMBAR COMFORT ZONE: Extra foam padding to minimize the pressure on your lower back while bolstering support.

Features and technologies

- MESH PANEL: Drain away excess water for quick drying and thermal regulated comfort.
- Comfortable fit.
- YKK front zipper.
- Side panels in stretch lining fabric for improved comfort.
- Armholes cut large for riding comfort.
- Loop at back neck to attach your goggles to your vest.
- D-ring for key lanyard.
- Coast Guard approved.

Ladies' Freedom PFD



285945 (US)
285946 (EU)
S, M, L, XL, 2XL, 3XL

● Black (90),
● Light Blue (81),
● Turquoise (Aqua) (76)

Descriptions

- PFD with a ultra-durable ecoprene outer shell.
- Environmentally friendly ecoprene material that is rubber free, flexible, lightweight, breathable and quick dry.
- Combination of PVC and polyethylene foam inserts.
- LUMBAR COMFORT ZONE: Extra foam padding to minimize the pressure on your lower back while bolstering support.
- MESH PANEL: Drain away excess water for quick drying and thermal regulated comfort.

Features and technologies

- Comfortable fit.
- YKK front zipper.
- Segmentations at front and back for better comfort and ease of movement.
- Side panels in stretch lining fabric for improved comfort.
- Armholes cut large for riding comfort.
- Loop at back neck to attach your goggles to your vest.
- D-ring for key lanyard.
- Coast Guard approved.

NEW Ladies' Motion PFD

286803 (US)
286804 (EU)
S, M, L, XL, 2XL, 3XL, 4XL

● Navy (89),
● Red (30)



Descriptions

- PFD with an ultra-durable polyester outer shell.
- Heavy-duty polyester material.
- Polyethylene foam inserts.
- Segmented foam at back bottom for increased comfort while seated.

Features and technologies

- Armholes cut large for riding comfort.
- Loop at back neck to attach your goggles to your vest.
- Coast Guard approved.

JUNIOR – PERSONAL FLOTATION DEVICE

Junior Explorer PFD (US/CA)

285954 (US)
285955 (EU)
L (55-88 lbs) (25-40 kg)

● Blue (80)



Descriptions

- PFD made of ultra-durable ecoprene outer shell for kids.
- Environmentally friendly ecoprene material that is rubber free, flexible, lightweight, breathable and quick dry.
- East of movement.
- Fitted.

Features and technologies

- Combination of PVC and polyethylene foam inserts.
- YKK front zipper.
- Armholes cut large for riding comfort.
- For kids of 50 to 90 lbs.
- Coast Guard Approved.

KIDS' – PERSONAL FLOTATION DEVICE

Kids' Sandsea PFD

285950 (US)
285952 (EU)
M (33-55 lbs) (15-25 kg),
L (55-88 lbs) (25-40 kg)

● Charcoal Grey (07)



Descriptions

- PFD made of heavy-duty polyester outer shell for kids.

Features and technologies

- Heavy-duty polyester material.
- Polyethylene foam inserts.
- Armholes cut large for comfort.
- Life jacket size Small: comes with Coast Guard approved pillow. Certified for general boating use, not watercraft.
- Coast Guard approved.

Rashguards



MEN'S – RASHGUARDS

NEW Long Sleeve Rashguard Beach

454493 S, M, L, XL, 2XL

● Black (90)



Descriptions:

- Long Sleeve Rashguard Beach with athletic fit.

Features and technologies:

- 87% polyester, 13% spandex.
- UV protection 50 UPF.
- Athletic fit.
- 4-way stretch.
- Quick dry.

Long Sleeve Rashguard Adventure

454460 S, M, L, XL, 2XL

● Black (90),
● Turquoise (Aqua) (76)



Descriptions:

- Long Sleeve Rashguard Adventure with a relaxed fit.

Features and technologies:

- 87% polyester, 13% spandex.
- UV protection 50 UPF.
- Relaxed fit.
- 4-way stretch.
- Quick dry.

Long Sleeve Rashguard Signature

454459 S, M, L, XL, 2XL

● Black (90),
● Warm Grey (15)



Descriptions:

- Long Sleeve Rashguard Signature with a relaxed fit.

Features and technologies:

- 87% polyester, 13% spandex.
- UV protection 50 UPF.
- Relaxed fit.
- 4-way stretch.
- Quick dry.

Short Sleeve Rashguard Beach

286798 S, M, L, XL, 2XL

● Hi-Vis Yellow (26),
● Warm Grey (15)



Descriptions:

- Short Sleeve Rashguard Beach with athletic fit.

Features and technologies:

- 87% polyester, 13% spandex.
- UV protection 50 UPF.
- Athletic fit.
- 4-way-stretch.
- Quick dry.

Short Sleeve Rashguard Signature

454487 S, M, L, XL, 2XL

● Black (90),
● Turquoise (Aqua) (76)



- Descriptions:**
- Short Sleeve Rashguard Signature with a relaxed fit.
- Features and technologies:**
- 87% polyester, 13% spandex.
 - UV protection 50 UPF.
 - Relaxed fit.
 - 4-way stretch.
 - Quick dry.

LADIES' - RASHGUARDS

Ladies' Long Sleeve Rashguard Beach

454464 S, M, L, XL

● Turquoise (Aqua) (76)



- Descriptions:**
- Ladies Long Sleeve Rashguard Beach with relaxed fit.
- Features and technologies:**
- 87% polyester, 13% spandex.
 - UV protection 50 UPF.
 - Relaxed fit.
 - 4-way stretch.
 - Quick dry.

Ladies' Long Sleeve Rashguard Signature

454465 S, M, L, XL

● Black (90),
● Navy (89)



- Descriptions:**
- Ladies Long Sleeve Rashguard Signature with a relaxed fit.
- Features and technologies:**
- 87% polyester, 13% spandex.
 - UV protection 50 UPF.
 - Relaxed fit.
 - 4-way stretch.
 - Quick dry.

Ladies' Short Sleeve Rashguard Beach

454461 S, M, L, XL

● Navy (89),
● Warm Grey (15)



- Descriptions:**
- Ladies Short Sleeve Rashguard Beach with athletic fit.
- Features and technologies:**
- 87% polyester, 13% spandex.
 - UV protection 50 UPF.
 - Athletic fit.
- 4-way stretch.
 - Cap sleeves.
 - Quick dry.

Ladies' Short Sleeve Rashguard Signature

454484 S, M, L, XL

● Black (90),
○ Ivory (97)



- Descriptions:**
- Ladies Short Sleeve Rashguard Signature with a relaxed fit.
- Features and technologies:**
- 87% polyester, 13% spandex.
 - UV protection 50 UPF.
- Relaxed fit.
 - 4-way stretch.
 - Quick dry.

Wetsuits



MEN'S - WETSUITS

Neoprene Riding Jacket

286787 S, M, L, XL, 2XL, 3XL

● Orange (12)



- Descriptions:**
- 2/1,5mm Neoprene Riding Jacket to be worn over your PFD for extra warmth and protection of the elements.
- Features and technologies:**
- 90% Neoprene stretch fabric, 10% Nylon.
 - 1, 5mm neoprene super stretch fabric at underarm, cuff and sleeve tabs.
- UV protection.
 - Adjustable hood & cuff.
 - YKK durable front and pockets zippers.

3 mm Escape Shorty Wetsuit

286788 XS, S, M, L, XL, 2XL, 3XL

● Navy (89)



- Descriptions:**
- 3mm Neoprene Escape Shorty Wetsuit for extra protection.
- Features and technologies:**
- 90% Neoprene stretch fabric, 10% Nylon.
 - UV protection.
 - Open collar for better mobility with adjustable velcro.
- YKK durable back zipper.
 - Glideskin seals on the edge of arms & legs.
 - Back zip with extended puller.

Montego Jacket

286810 S, M, L, XL, 2XL

● Navy (89)



- Descriptions:**
- 3mm neoprene Montego Jacket for protection against the elements.
- Features and technologies:**
- 90% Neoprene stretch fabric, 10% Nylon.
 - Super stretch fabric on sides: 82% nylon, 18% spandex.
 - UV protection.
 - Athletic fit.
- YKK durable front zipper.
 - Hidden keyloop.
 - Super stretch neoprene at cuff for easy wrist opening.
 - Flatlock stitch construction to prevent chafing.

NEW Montego Pants

286809 S, M, L, XL, 2XL

● Black (90)



- Descriptions:**
- 3/2mm neoprene Montego Pants for protection against the elements.
- Features and technologies:**
- 90% Neoprene, 10% Nylon.
 - 2mm super stretch fabric on sides: 82% nylon, 18% spandex.
 - 1mm neoprene + abrasion resistant knees for better durability.
- UV protection.
 - Athletic fit.
 - Ergonomic waistband and tall back for more coverage.
 - Side pocket with zipper + Key loop

NEW Neoprene Shorts

286808 S, M, L, XL, 2XL, 3XL ● Black (90)



- Descriptions:**
- 2mm neoprene shorts.
- Features and technologies:**
- 90% Neoprene stretch fabric, 10% Nylon.
 - UV protection.
 - Fitted.
 - Ergonomic waistband and tall back for more coverage.
- Seamless seam construction to prevent friction on the skin.
 - Side pocket + key loop.

NEW Protective Undershorts

454581 XS, S, M, L, XL, 2XL, 3XL ● Black (90)



- Descriptions:**
- New breathable Protective Riding Shorts perfect for warmer weather.
- Features and technologies:**
- 80% Nylon, 20% Spandex.
 - 2mm neoprene stretch fabric around seating area for better protection.
 - UV protection.
 - Inner elastic waistband.
 - Inseam: 6 3/4"

LADIES' - WETSUITS

NEW Ladies' 3 mm Exotic Shorty Wetsuit

286813 XS, S, M, L, XL, 2XL ● Deep Purple (42)



- Descriptions:**
- 3/2mm neoprene Exotic Shorty Wetsuit.
- Features and technologies:**
- 90% neoprene stretch fabric, 10% nylon.
 - 2mm side super stretch fabric: 94% Nylon, 6% Spandex.
 - 3mm neoprene outershell and under flap.
 - UV protection.
- Open collar for better movement ease with adjustable velcro.
 - Glideskin seals on the edge of arm & leg.
 - YKK durable back zipper with Sea Doo puller.
 - Side pocket + key loop.

Ladies' Montego Jacket

286812 XS, S, M, L, XL, 2XL ● Deep Purple (42)



- Descriptions:**
- Ladies 3mm neoprene Montego Jacket for protection against the elements.
- Features and technologies:**
- 90% neoprene, 10% nylon.
 - Super stretch fabric: 82% nylon, 18% spandex.
 - UV protection.
 - Athletic fit.
- YKK durable front and pockets zippers.
 - Hidden keyloop.
 - Super stretch neoprene at cuff for easy wrist opening.
 - Flatlock stitch construction to prevents chafing.

LADIES' - WETSUITS

NEW Ladies' Montego Pants

286811 XS, S, M, L, XL, 2XL ● Black (90)



- Descriptions:**
- Ladies 3/2mm neoprene Montego Pants for protection against the elements.
- Features and technologies:**
- 90% Neoprene, 10% Nylon.
 - 2mm super stretch fabric on sides: 82% nylon, 18% spandex.
 - 1mm neoprene + abrasion resistant knees for better durability.
- UV protection.
 - Athletic fit.
 - Ergonomic waistband and tall back for more coverage.
 - Side pocket with zipper + Key loop

Ladies' Neoprene Shorts

286786 XS, S, M, L, XL, 2XL ● Black (90)



- Descriptions:**
- Ladies 2mm Neoprene Riding Shorts.
- Features and technologies:**
- 90% Neoprene stretch fabric, 10% Nylon.
 - UV protection.
 - Made to protect from water intrusion and overall safety.
- Yoga-type waistband.
 - Flatlock stitched construction is non chaffing on skin.
 - Sea-doo print on side.

NEW Ladies' Protective Undershorts

286799 XS, S, M, L, XL, 2XL, 3XL ● Black (90)



- Descriptions:**
- New breathable Protective Riding Shorts perfect for warmer weather.
- Features and technologies:**
- 82% Nylon, 18% Spandex.
 - 2mm neoprene super stretch fabric around seating area for protection against water intrusion.
 - UV protection.
 - Inner elastic waistband.
 - Inseam: 4 1/4"

Dry Suits

Sea-Doo Dry Suit | 440846 S, M, L, XL, 2XL | ● Yellow (10)



- Descriptions:**
- First drysuit customized for PWC
- Features and technologies:**
- 100% Nylon
 - T-ZIP waterproof front zipper (plastic)
 - 1 chest pocket - Sealed seams
 - Non-slip material at seat and friction printing
 - Elastic at back waist
 - Adjustable wrists
 - Adjustable and removable hood
 - Neoprene collar and sleeve-ends
 - Integrated boots
 - D-ring killer loop at waist right side

Sea-Doo Thermal Top/ Pants | 454216 (Top) · S, M, L, XL | 454217 (Pants) · S, M, L, XL | ● Black (90)



- Features and technologies:**
- 95% Nylon, 5% Spandex

Sea-Doo Thermal Gloves | 446319 · M, L, XL | ● Black (90)



- Features and technologies:**
- 90% Neoprene, 10% Nylon

Sea-Doo Thermal Hood | 447702 · M, L, XL | ● Black (90)



- Features and technologies:**
- 90% Neoprene, 10% Nylon

Eyewear

UNISEX - GOGGLES

Sea-Doo Riding Goggles | 448623 Onesize | ● Green (70), ● Orange (12), ● Silver (08)



- Features and technologies:**
- Featuring anti-fog technology with colored chrome lenses.
 - Indirect ventilation frame.
 - Adjustable strap system.
 - Goggles-to-PFD attachment safety cord.
 - Optional Riding Goggles RX Insert (448624) (sold separately).
 - 90% plastic, 10% neoprene.

NEW Sea-Doo Wave Polarized Floating Sunnies | 448717 Onesize | ● Gold (11), ● Green (70), ● Red (30), ● Silver (08), ● Turquoise (Aqua) (76)



- Features and technologies:**
- Polarized chrome colored lenses.
 - Floating frame technologies.
 - UV400 Protection.
 - Air-injected arms for floatability and light weight.
 - Adjustable safety strap system.
 - 90% plastic, 10% neoprene.

NEW Sea-Doo Sand Polarized Floating Sunnies | 448746 Onesize | ● Blue (80), ● Gold (11), ● Green (70), ● Orange (12), ● Red (30)



- Features and technologies:**
- Polarized chrome colored lenses.
 - Floating frame technologies.
 - UV400 Protection.
 - Air-injected arms for floatability and light weight.
 - Removable and adjustable safety strap system.
 - 90% plastic, 10% neoprene.

NEW Sea-Doo Lagoon Polarized Floating Sunnies Goggles | 448747 Onesize | ● Blue (80), ● Brown (04), ● Orange (12), ● Pink (36)



- Features and technologies:**
- Polarized chrome colored lenses.
 - Floating frame technologies.
 - UV400 Protection.
 - Air-injected arms for floatability and light weight.
 - Removable and adjustable safety strap system.
 - 90% plastic, 10% neoprene.

Handwear

UNISEX - HANDWEAR

Neoprene Gloves | **286729** XS, S, M, L, XL, 2XL | ● Black (90)



- Descriptions:**
- 1.5mm Neoprene Gloves for cold.
- Features and technologies:**
- 90% Neoprene, 10% Nylon.
 - UV protection.
 - Super stretch material for superior comfort and mobility.
 - Anti-slip rubberized print at palms.
 - Pre-shaped fingers.

NEW Sea-Doo Choppy Gloves | **446332** XS, S, M, L, XL, 2XL, 3XL | ● Black (90), ● Deep Purple (42), ● Turquoise (Aqua) (76)



- Descriptions:**
- Sea-Doo Choppy Gloves with stretch fabric.
- Features and technologies:**
- 74% nylon, 17% polyurethane, 8% chloroprene Rubber, 1% polyester.
 - Double stitching in high stress areas for durability.
 - Touch screen.
 - Clarino[®] Nash palm material with 2mm padding and rubberized Pro-Grip at palm to ensure a solid hold.
 - Stretch neoprene cuffs.

NEW Sea-Doo Choppy Shorty Gloves | **446333** XS, S, M, L, XL, 2XL, 3XL | ● Black (90), ● Turquoise (Aqua) (76)



- Descriptions:**
- Sea-Doo Choppy Shorty Gloves with stretch fabric.
- Features and technologies:**
- 75% nylon, 18% polyurethane, 7% chloroprene Rubber.
 - Double stitching in high stress areas for durability.
 - Clarino[®] Nash palm material with 2mm padding and rubberized Pro-Grip at palm to ensure a solid hold.
 - Stretch neoprene cuffs.

Footwear

UNISEX - FOOTWEAR

Sea-Doo Riding Boots | **444257** 7, 8, 9, 10, 11, 12, 13 | ● Black (90)



- Descriptions:**
- Sea-Doo Boots made for performance riding.
- Features and technologies:**
- 50% EVA, 40% mesh, 10% lycra.
 - Antimicrobial treatment.
 - Lightweight EVA midsoles.
 - All-around protective urethane coating.
 - Mesh uppers and perforated insoles for fast water evacuation.
- Non-slip and non-marking outsoles.
 - These amphibian mid cut boots will allow you to ride hard while protecting your ankles from impact against the hull.

Sea-Doo Water Shoes | **444256** 7, 8, 9, 10, 11, 12, 13 | ● Turquoise (Aqua) (76), ○ White (01)



- Descriptions:**
- Lightweight Sea-Doo Water Shoes.
- Features and technologies:**
- 45% mesh, 40% EVA, 15% lycra.
 - Antimicrobial treatment.
 - Lightweight EVA midsoles.
 - All-around protective urethane coating.
 - Mesh uppers and perforated insoles for fast water evacuation.
- Non-slip and non-marking outsoles.
 - Amphibian low cut shoes that offer protection on the water and running shoe like outside the water."

Sea-Doo Neoprene Boots | **286702** 5, 6, 7, 8, 9, 10, 11, 12, 13 | ● Black (90)



- Descriptions:**
- 5mm Neoprene Boots to keep you feet warm during your ride.
- Features and technologies:**
- 90% Neoprene, 10% Nylon.
 - Double-glued and blind stitched neoprene construction.
 - Non-corrosive heavy-duty zipper.
 - Flexible rubber toe and heel protection caps.
- Molded outsole with non-slip tread design.
 - Anti-slip insole.

Sportswear

MEN'S - SPORTSWEAR

NEW Windproof Jacket | 454483 S, M, L, XL, 2XL, 3XL | ● Black (90)



- Descriptions:**
- Windproof Lightweight jacket.
- Features and technologies:**
- 100% polyester.
 - Water resistant, windproof and quick dry.
 - Stowable hood.
 - 2 hand pockets & 1 chest pocket.

Sea-Doo Sunset Tech Zip-up | 454458 S, M, L, XL, 2XL, 3XL | ● Navy (89)



- Descriptions:**
- Sea-Doo Sunset Tech Zip-up hoodie.
- Features and technologies:**
- 95% polyester, 5% spandex.
 - Kangaroo pocket.
 - Adjustable hood.
 - 2 hand pockets & 1 chest pocket.

Sea-Doo Hoodie Signature | 454456 S, M, L, XL, 2XL, 3XL | ● Heather Grey (27)



- Descriptions:**
- Sea-Doo Hoodie Signature.
- Features and technologies:**
- 60% cotton, 40% polyester fleece.
 - Kangaroo pocket.
 - Drawcord adjustable hood.

NEW Adventure Cargo Shorts | 454490 S, M, L, XL, 2XL, 3XL | ● Black (90), ● Warm Grey (15)



- Descriptions:**
- Adventure Cargo Shorts with relaxed fit.
- Features and technologies:**
- 92% nylon, 8% spandex.
 - UV protection 30 UPF.
 - Breathable Fabric.
 - Relaxed fit.
 - Stretch engineered waistband with belt and buckle.
- 2 Hand pocket & 1 side pocket.
 - Hidden Key loop.
 - Inseam: 9".

NEW Beach Boardshorts | 454491 S, M, L, XL, 2XL, 3XL | ● Black (90), ● Turquoise (Aqua) (76)



- Descriptions:**
- Beach Boardshorts with light fabric.
- Features and technologies:**
- 90% polyester, 10% spandex.
 - 4-way stretch fabric.
 - Adjustable waist with drawcord
 - Back zippered pocket.
 - Inseam: 8".

Sea-Doo Signature Cap | 454518 Onesize | ● Black (90), ● Navy (89), ● Pink (36), ● Warm Grey (15)



- Descriptions:**
- Sea-Doo Signature Cap.
- Features and technologies:**
- 100% Cotton.
 - Snapback closure at back.

NEW Sea-Doo Tech Short Sleeve Polo | 454482 S, M, L, XL, 2XL, 3XL | ● Heather Charcoal (29), ● Heather Grey (27), ○ White (01)





- Features and technologies:**
- 85% polyester, 15% spandex.
 - Relaxed fit.
 - Quick dry.
 - 2 buttons placket on neck line.
 - UPF 30 UV protection.

NEW Sea-Doo UV Protection T-Shirt | 454486 S, M, L, XL, 2XL, 3XL | ● Heather Charcoal (29), ● Navy (89)



- Features and technologies:**
- 100% polyester.
 - UV protection 30 UPF.
 - Relaxed fit.
 - Quick dry.
 - 3D chest logo.
 - Shoulder black welding band.

Retro Sea-Doo T-Shirt	454457 S, M, L, XL, 2XL, 3XL	● Black (90), ○ White (01)
 <p>Features and technologies:</p> <ul style="list-style-type: none"> • 100% cotton. • Relaxed fit. 		

Stamp Sea-Doo T-Shirt	454453 S, M, L, XL, 2XL, 3XL	● Heather Grey (27), ● Turquoise (Aqua) (76)
 <p>Features and technologies:</p> <ul style="list-style-type: none"> • 60% cotton, 40% polyester jersey. • Relaxed fit. 		

Sea-Doo Signature T-Shirt	454452 S, M, L, XL, 2XL, 3XL	● Black (90), ● Turquoise (Aqua) (76), ○ White (01)
 <p>Features and technologies:</p> <ul style="list-style-type: none"> • 100% cotton. • Relaxed fit. 		

LADIES' - SPORTSWEAR

NEW Ladies' Windproof Jacket	454481 S, M, L, XL, 2XL, 3XL	● Navy (89)
 <p>Descriptions:</p> <ul style="list-style-type: none"> • Ladies Windproof lightweight jacket. <p>Features and technologies:</p> <ul style="list-style-type: none"> • 100% nylon. • Water resistant, windproof and quick dry. • Stowable hood. • 2 exterior hand pockets. • Sea-Doo hologram logo at back. 		

NEW Ladies' Crewneck Sweatshirt	454485 XS, S, M, L, XL, 2XL	○ Ivory (97), ● Yellow (10)
 <p>Descriptions:</p> <ul style="list-style-type: none"> • Ladies Crewneck Sweatshirt with relaxed fit. <p>Features and technologies:</p> <ul style="list-style-type: none"> • Real heather: 100% cotton. • Solid color: 60% cotton, 40% polyester jersey. • Relaxed fit. • Rib on collar, cuffs and hem. • Real heather. 		

Ladies' Beach Cap	454469 Onesize	● Navy (89)
 <p>Descriptions:</p> <ul style="list-style-type: none"> • Ladies lightweight Beach Cap. <p>Features and technologies:</p> <ul style="list-style-type: none"> • 80% polyester, 20% cotton. • Mesh at back. • Foam crown. • Snapback closure at back. 		

NEW Ladies' Visor Cap	454480 Onesize	● Black (90)
 <p>Descriptions:</p> <ul style="list-style-type: none"> • Ladies Visor Cap. <p>Features and technologies:</p> <ul style="list-style-type: none"> • 100% cotton. • Back adjustment. 		

NEW Ladies' Racerback Tank	454488 XS, S, M, L, XL, 2XL	○ White (01)
 <p>Descriptions:</p> <ul style="list-style-type: none"> • Ladies Racerback Tank with relaxed fit. <p>Features and technologies:</p> <ul style="list-style-type: none"> • 77% polyester, 18% tencel, 5% spandex. • Breathable, lightweight and comfortable fabric. • Relaxed fit. • Longer at back. 		

Ladies' Retro T-Shirt	454468 XS, S, M, L, XL, 2XL	● Navy (89)
 <p>Features and technologies:</p> <ul style="list-style-type: none"> • 95% cotton, 5% spandex jersey. • Fitted fit. • Stretch fabric. 		

LADIES' - SPORTSWEAR

Ladies' Sea-Doo Signature T-Shirt	454451 XS, S, M, L, XL, 2XL	● Heather Grey (27), ● Navy (89), ○ White (01)
<div data-bbox="92 367 385 640" data-label="Image"> </div> <p>Features and technologies:</p> <ul style="list-style-type: none"> 95% cotton, 5% spandex jersey. Stretch fabric. Fitted fit. 		

KIDS'/TEEN - SPORTSWEAR

Youth Sea-Doo T-Shirt	454462 3-4, 5-6, 7-8, 10-12, 14-16	● Navy (89), ○ White (01)
<div data-bbox="92 819 385 1081" data-label="Image"> </div> <p>Features and technologies:</p> <ul style="list-style-type: none"> 100% cotton. Relaxed fit. 		

UNISEX'

NEW Sea-Doo Bucket Hat	454624 Onesize	● Black (90)
<div data-bbox="133 1255 341 1396" data-label="Image"> </div> <p>Descriptions:</p> <ul style="list-style-type: none"> Sea-Doo Bucket Hat with logo patch. <p>Features and technologies:</p> <ul style="list-style-type: none"> 100% cotton twill. 		

Adventure Wide Brim Hat	454478 Onesize	● Navy (89), ● Warm Grey (15)
<div data-bbox="103 1480 371 1774" data-label="Image"> </div> <p>Descriptions:</p> <ul style="list-style-type: none"> Adventure Wide Brim Hat. <p>Features and technologies:</p> <ul style="list-style-type: none"> 100% cotton. Stretch and quick-drying fabric. Adjustable cord chin strap. Snap-up sides. Side air vents. 		

Retro Flat Cap	454466 Onesize	● Black (90), ● Navy (89)
-----------------------	-----------------------	---------------------------

	<p>Descriptions:</p> <ul style="list-style-type: none"> Lightweight Retro cap with flat peak. <p>Features and technologies:</p> <ul style="list-style-type: none"> 60% polyester, 40% cotton. Mesh at back. Foam crown. Snapback closure at back.
--	--

Sea-Doo Mesh Cap	454470 Onesize	● Black (90), ● Hi-Vis Yellow (26), ● Navy (89)
-------------------------	-----------------------	---

	<p>Descriptions:</p> <ul style="list-style-type: none"> Lightweight Sea-Doo Mesh Cap. <p>Features and technologies:</p> <ul style="list-style-type: none"> 60% polyester, 40% cotton. Snapback closure at back.
--	--

Sea-Doo Rag	454455 Onesize	● Black (90), ○ White (01)
--------------------	-----------------------	----------------------------

	<p>Descriptions:</p> <ul style="list-style-type: none"> Fast-drying Sea-Doo Rag. <p>Features and technologies:</p> <ul style="list-style-type: none"> 100% polyester. Lightweight, moisture-wicking, breathable fabric. SPF 50 UV protection. Instantly transform into a headband or a facemask.
--	---



SEA-DOO.COM

